

**Honeywell**

# **Tuxedo Touch™ Wi-Fi®**

**Models TUXWIFIS and TUXWIFIW**

**Home Automation System**

**Installation and  
Setup Guide**

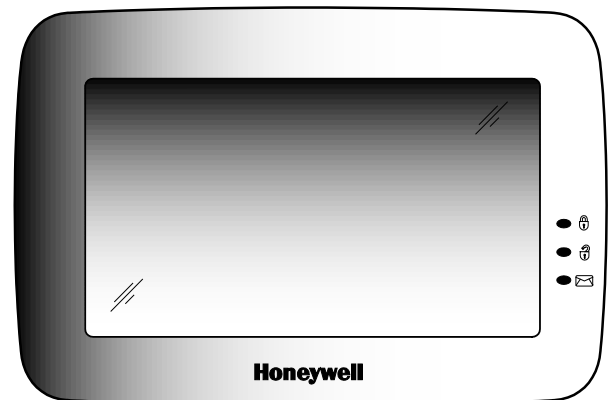

---

Z-Wave devices are identified by the Z-Wave logo and can be purchased from your local retailer.

Z-Wave® is a registered trademark Sigma Designs, Inc. and/or its subsidiaries.

---



# Table of Contents

## ABOUT THE SYSTEM

<i>Tuxedo Features</i> .....	1
Control Panel Compatibility .....	2
Front Panel LED's .....	3

## MOUNTING

Standard Mounting with Mounting Plate .....	3
Mounting Without Mounting Plate .....	3
Mounting Using a Center Securing Screw .....	4
<i>Wiring</i> .....	4
ECP Wire Limitations .....	4
Supplementary Power Supply Connections .....	5

## PROGRAMMING THE CONTROL PANEL

<i>Conventional Programming Methods</i> .....	5
Residential Control Panels .....	5
Commercial Control Panels (Non-Turbo) .....	6
Vista-Turbo .....	6
Commercial Control Panels .....	6
<i>Quick Programming (VIP Mode)</i> .....	6
<i>Data Entry Keyboard</i> .....	6

## FIRST TIME SETUP

<i>First Time Power Up (Keypad Initialization)</i> .....	7
1: Operational Mode Setup .....	7
2: Set ECP Address/RIS Automation Address .....	8
3: Honeywell End User License Agreement (EULA) .....	10
4: Network (LAN/Wi-Fi) Setup .....	10
5: Important Operation Information .....	10
6: Remote Login .....	10
7: Voice Disclaimer .....	10
8: Voice Tutorial and Setup .....	11

## HOME PAGE

## SETUP SCREEN

<i>System Information</i> .....	13
Software Upgrades .....	13
Display & Audio Setup .....	14
Language Selection (if applicable) .....	14
Screen Time Outs .....	14
Temperature Unit .....	15
Clean Screen .....	15
<i>IP (Setup)</i> .....	15
Wi-Fi Setup .....	15
Manual Network Setup .....	15
Static Network .....	15
Port Settings .....	15
Webserver Access .....	16
Local Access .....	16
Web Server IP Address Access .....	17
Connecting the Tuxedo to a mobile device .....	17
Local Web Server URL Access .....	18
Remote Access Using Port Forwarding .....	18
<i>Email Setup</i> .....	19
User Email Setup .....	19
Defining Event Types .....	20

## SYSTEM SETUP

<i>Quick Programming</i> .....	21
Quick Programming Menu's .....	21
<i>CS Setup (Central Station)</i> .....	22
ECP Address .....	22
Options .....	22
Code Authority .....	22
Device Events .....	22
<i>Time/Date Setup</i> .....	22
<i>User Codes</i> .....	23
Authority Levels .....	23
Add a User .....	23
LCD Display Test .....	24
<i>Audio Test</i> .....	24
LED Test .....	24
Calibration .....	25
Z-Wave Test .....	25
Keypad Reset .....	26
End User License Agreement (EULA) .....	26
Factory Default .....	26
Output Setup .....	26
Night Setup Function .....	26
Power Mode Setup .....	27
<i>Multimedia</i> .....	27
Picture & Slide Show Setup .....	27
<i>Camera Options and Setup</i> .....	28
First Time Setup .....	28
Add/Edit Options .....	29
Setting the Camera's Wi-Fi .....	30
Advanced Camera Settings .....	30
Removing Cameras .....	31
<i>Viewing Cameras</i> .....	31
<i>Video Recording &amp; Event Viewing</i> .....	31
Manual Video Recording .....	32
Using Third Party Cameras .....	32
Event Viewing .....	32
Video Playback .....	33
Creating Scenes for Camera Recording .....	33
<i>Message (Voice Memo's)</i> .....	33
Recording a Message .....	34
Listening to a New Message .....	34
Deleting Message(s) .....	34

## Z-WAVE SETUP

<i>Z-Wave device Management Screen Device List</i> .....	35
<i>Z-Wave Device Management Buttons Defined</i> .....	36
<i>Adding and Deleting Z-Wave Devices</i> .....	36
<i>Z-Wave Device Setup</i> .....	38
Changing the Name .....	38
Changing the Icon .....	38
Association Details .....	39
<i>Z-Wave Network Update</i> .....	39
Individual Device Update .....	39
Complete Network Update .....	39
<i>Creating Scenes</i> .....	40
Defining Scenes .....	41

*Scene Setup Options*..... 43  
 Detailed Scene Configuration ..... 45  
*Room Setup*..... 46  
 Secondary Tuxedo Controller ..... 46  
 Synchronizing Device Names ..... 47  
 Removing Secondary Tuxedo's ..... 47  
 Manual Z-Wave Device Control ..... 47

**INTEGRATING TOTAL CONNECT REMOTE SERVICES**

*Enabling Devices for Total Connect* ..... 48  
*Controlling Automation (Z-Wave) Devices Remotely* 48

**VIEWING AND CONTROLLING TOTAL CONNECT SCENES FROM TUXEDO**

*Creating Scenes in Total Connect*..... 49  
 Total Connect Server Screen for Troubleshooting..... 49

**APPENDIX A: IMPORTANT NOTES**

*General Notes* ..... 50  
*Commercial System Notes* ..... 50  
*Residential System Notes*..... 50  
*User Related Notes* ..... 50

**APPENDIX B: Z-WAVE NOTES**

*Z-Wave Compatible Devices* ..... 51

**APPENDIX C: WIRELESS RANGE**

Things to consider regarding RF range:..... 52  
*Controlling Devices:*..... 52  
*Effects of Home Construction on Wireless Range between Z-Wave Enabled Devices* ..... 52

**NAVIGATION ICONS**

**SPECIFICATIONS**

**NOTE:** This device is a Security Enabled Z-Wave Controller



## About the System

This guide provides information to install and set-up Honeywell's Tuxedo Touch™ Wi-Fi® Home Automation and Security System (herein referred to as Tuxedo). Tuxedo is an Advanced User Interface (AUI) device, which combines wireless home automation and security. Tuxedo connects to a VISTA® series control panel via the keypad (ECP) terminals, or used as a stand-alone unit for automation purposes.

## Tuxedo Features

Feature	Description
<b>Local Wi-Fi Access</b>	The Tuxedo keypad contains a built-in web server, which allows local Wi-Fi access to the system via any web-enabled device. In addition, a user account can be set up, which provides a user name and password login before entering the Tuxedo home screen to protect against unauthorized access.
<b>Honeywell Total Connect™ Remote Services</b>	Tuxedo supports Remote Services for controlling Z-Wave devices and scenes remotely from an associated Total Connect™ account (contact an AlarmNet® representative to open an account if necessary). With Tuxedo automation, Z-Wave devices can be controlled from a smart phone, iPad®, Android™ Tablet, or PC using Total Connect. Tuxedo includes webpage support for IE9.
<b>Remote Access(Port Forwarding)</b>	Tuxedo's remote access option allows the user to access Tuxedo's menus directly via the Internet when away from home. Port forwarding set in the router is required. Up to five user logins available. Refer to the router's instructions for details on port forwarding. See "Supported Browsers Section."
<b>Z-Wave Devices</b>	Tuxedo supports various Z-Wave devices, including lamp modules, dimmer modules, door locks, thermostats, water valves, garage door controllers and shade openers.
<b>Automation Scenes</b>	Define system actions for automatic start and stop parameters when certain conditions occur. Supports up to 30 scenes locally and 20 remotely through Total Connect.
<b>Cameras</b>	View up to four cameras at the same time with a maximum enrollment of 32 cameras.
<b>Video</b>	View videos from the Home screen. A video converter is required, requires MP4 format for playback. See Video Setup section for details.
<b>Security System</b>	Control the security system via Tuxedo menus. Offers burglary protection and may provide fire, carbon monoxide and emergency protection.
<b>Email Notification</b>	Receive email notifications when certain events occur. Notifications are to up four email addresses.
<b>Weather Forecast</b>	The *Weather forecast (if enabled) is displayed on the "Home" screen. Press the "Weather" feature to enter your location and temperature unit.
<b>Output Setup Function</b>	Tuxedo can activate/deactivate up to 18 pre-defined panel outputs (if programmed in the control panel). These output functions are typically used to turn on lights or activate relay devices.
<b>Safe Mode</b>	In the rare event that the keypad cannot successfully communicate in its graphic mode with the control panel, the Safe Mode is a backup mode that ensures that you can communicate with the system. In this mode, the keypad operates much like a standard non-graphic keypad so that you can control the system until the problem is corrected. <b>IMPORTANT</b> DO NOT perform panel programming while in the Safe Mode. Performing panel programming while in Safe Mode may cause the panel and keypad to become out of synchronization. DO NOT use several hardwired motion detectors in high traffic locations. The high quantity of signals received by the panel may cause the keypad to enter the Safe Mode. The actual number of installed detectors depends on the amount of traffic and the number of detectors being used. High traffic can cause Safe Mode with as few as three detectors.
<b>Blank Display</b>	The Blank Display (EN50131) feature prevents unauthorized users from viewing the status of the Security System by returning to the Home screen and turning off the Armed and Ready status LEDs. When the EN50131 Display is turned ON: Tuxedo returns to the "Home" screen after 30 seconds and "Armed" and "Ready" LEDs turn OFF. The "To Homepage After" time setting changes to 30 seconds and the time is non-selectable. The "Auto Slideshow After" is preset to "1" minute and cannot be changed. The Security, Message and Lighting screen does not display system status until an authorized user code is entered. The "Setup" menu does not display system status until an authorized user code is entered. Videos cannot be played.
<b>Night Setup</b>	Pressing <b>NIGHT</b> icon the system in the <b>STAY INSTANT</b> mode by default. This function can be changed to arm in one of several other modes if desired. Refer to the "Night Setup" section for details.

Feature	Description
<b>Switchable Themes</b>	Switch from normal view to mobile view depending on the type of device used with the Tuxedo. Refer to Remote Access section for details.
<b>Software Upgrades</b>	Software upgrades may be available for this product. To ensure you have the latest version, check the version in your system (see the Software Upgrades section for details).

<b>UL</b>	Web server hosting, Remote Arming/Disarming/Programming, Wi-Fi, and Email Notifications are supplementary only and not listed for use in UL compliant installations.
-----------	--

## Control Panel Compatibility

The table below lists compatible control panels and their software revision levels.

**NOTE:** For SIA installations used with a VISTA-128BPTSIA Control, see the SIA CP-01 Quick Reference Chart by visiting: <https://mywebtch.honeywell.com/>

Alarm System	Maximum Number of Keypads	Minimum Software Revision Level	Voice Chime
VISTA-15P, VISTA-20P, FA148CP, FA168CPS	2	3.0	Yes
VISTA-20P, FA168CPS	4	5.0	Yes
* VISTA-21IP	4	1.0	Yes
VISTA-128BP, VISTA-250BP	3	4.4	No
VISTA-128BPEN	3	7.0	No
VISTA-128FBP, VISTA-250FBP, FA1670C	3	4.1	No
VISTA-128FBPN	3	5.1	No
VISTA-128BPT, VISTA-250BPT, VISTA-128BPTSIA, FA1660CT	6	10.1	Yes
FA1660C, FA1700C	3	3.0	No
**Vista-128FBPT, Vista-250FBPT, Vista-32FBPT	6	10.0	Yes
* Not evaluated by UL.			
** Not for UL 864 Commercial Fire Alarm Applications			
<b>NOTE:</b> Tuxedo may only be used in the following UL/cUL installations: UL 365, UL609, UL 985, UL1023, UL 1610, CAN/ULC-S303, CAN/ULC-S304, ULC-S545, ULC/ORD-C1023, and ANSI/SIA CP-01-2010.			

### To obtain the software revision level on commercial panels:

- From program mode, enter **#92** on the keypad (this can be done from the Console Mode). The second line of the keypad displays the software revision level (w/out the decimal point).



### To obtain the software revision level on residential panels:

- From the Home Screen press **Setup > System Setup > Central Station Setup >** enter installer code **> Panel Configuration**; the software revision level is displayed.
- The keypad sound suppression feature is available in some commercial panels and is not compatible with the Tuxedo keypad.
- The 'Voice Chime' feature is a residential control feature only (refer to the table above).

**NOTE:** If using the maximum number of keypads, an additional auxiliary power supply may be needed. Refer to the "Wiring" and "Specifications" section for more information.

## Front Panel LED's

The Tuxedo keypad has three LEDs as follows:

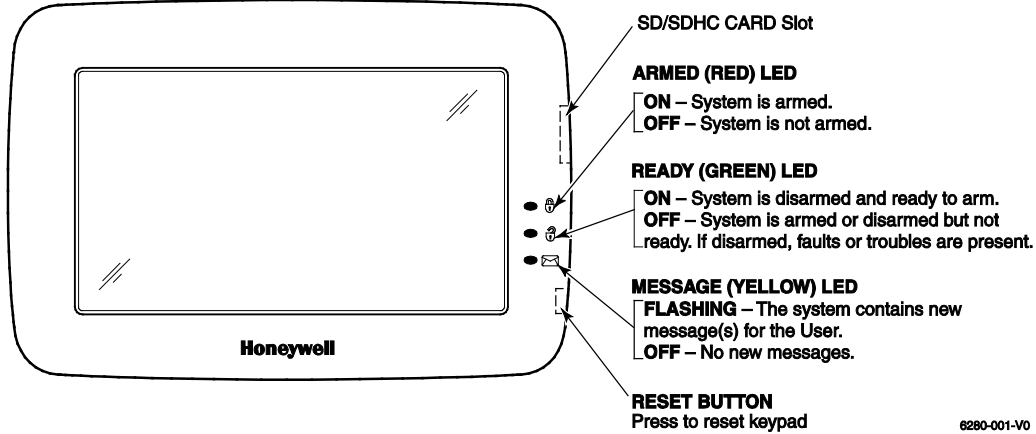

## Mounting

Tuxedo is for indoor use within the protected area only and mounted at a comfortable viewing level. Avoid mounting in areas of high condensation such as bathrooms or in locations where bright light or sunlight shines directly on the screen. Tuxedo can be mounted with or without the mounting plate. Use the center securing screw for European installations.

### Standard Mounting with Mounting Plate

1. Select a mounting location.
2. Detach the mounting plate by sliding downward.
3. Use the mounting plate to mark the location of the mounting holes on the mounting surface and check for level.
4. Locate the mounting plate over the mounting surface such that the wire/cable access openings are aligned while passing the wires/cable through the case back.  
**\*\*Go to Wiring and complete wiring.**
5. Secure the mounting plate to mounting surface using four screws (supplied).
6. Slide keypad onto mounting plate.

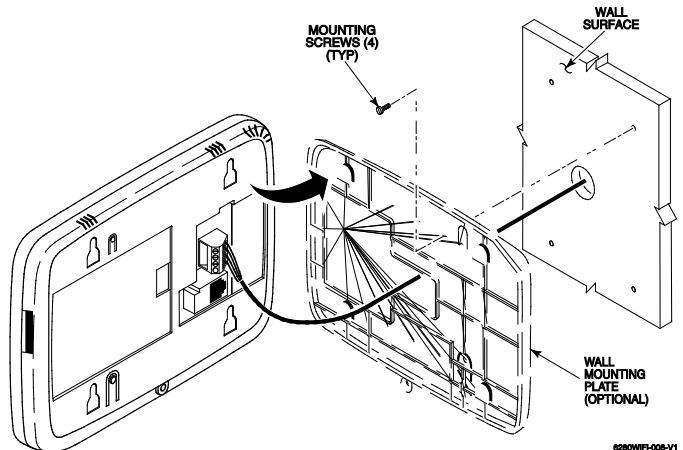

### Mounting Without Mounting Plate

1. Select a mounting location.
2. Detach the mounting plate by sliding downward and discard.
3. Use the template (provided in the carton) to mark the location of the mounting screws and the cut-out for the keypad assembly on the mounting location. Check for level.
4. Install four screws (supplied) in the mounting surface leaving screw heads 1/8" above the mounting surface.
5. Locate the case back over the mounting surface such that the opening is aligned with the wire/cable access opening on the mounting surface while passing the wires/cable through the opening in the case back. **\*\*Go to "Wiring" and complete wiring.**
6. Mount keypad by sliding onto the screw heads.

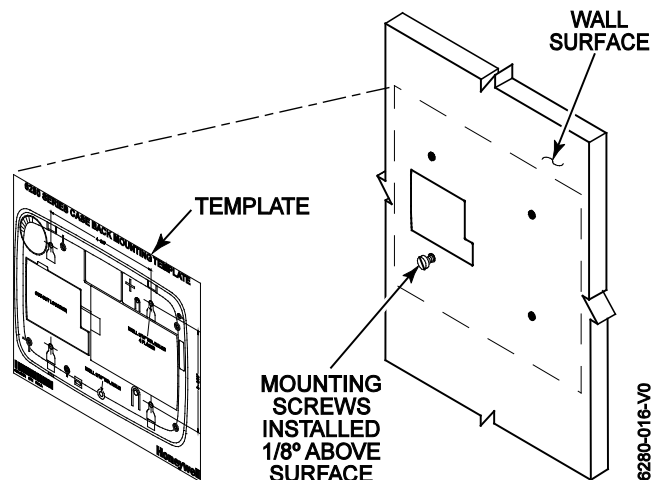



## Mounting Using a Center Securing Screw

**NOTE:** Applies to European Installations.

1. Detach case front by removing the two bottom screws. Gently pull up using a screwdriver if necessary and pry apart. Lift off cover.
2. Mount Tuxedo in its final location, (see “Standard Mounting” or “Mounting without the mounting plate”) install center securing screw (supplied) and tighten to mounting surface.
3. Replace the case front and secure using the two bottom screws.

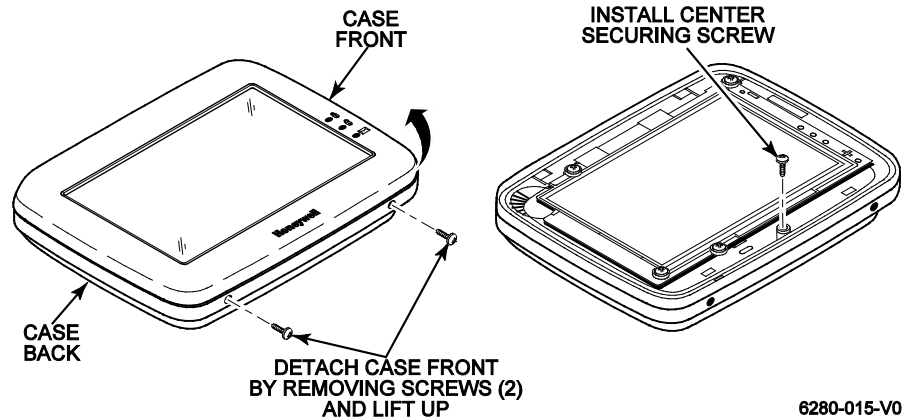

6280-015-V0



The European mounting procedure has not been evaluated for agency compliant application.

## Wiring

Connect the Tuxedo in parallel with keypads and other peripheral devices using the keypad data (ECP) bus, by adhering to the standards below.

### ECP Wire Limitations

Connect keypads and other addressable devices as shown in “**Supplementary Power Supply Connections**” section. The table below establishes ECP device wire gauge:

Wire Gauge	Length
#22 gauge	150 feet
#20 gauge	240 feet
#18 gauge	350 feet
#16 gauge	550 feet



Tuxedo draws up to 340mA for 9.6VDC, 260mA for 12VDC, 250mA for 13.8VDC. If you power Tuxedo from your panel's Aux Power output, check your panel's Installation and Setup Guide and verify that this device and others do not exceed your panel's Aux Power output capability. If it does, a supplementary power supply is needed.

- If more than one Tuxedo is wired to one run, then the maximum lengths must be divided by the number of keypads on the run. (e.g., the maximum length is 75 feet if two Tuxedos are wired on a #22-gauge run).
- If Tuxedo is used as the primary system keypad, maximum wire run lengths must not exceed the lengths listed in the table above.

**Supplementary Power Supply Connections**

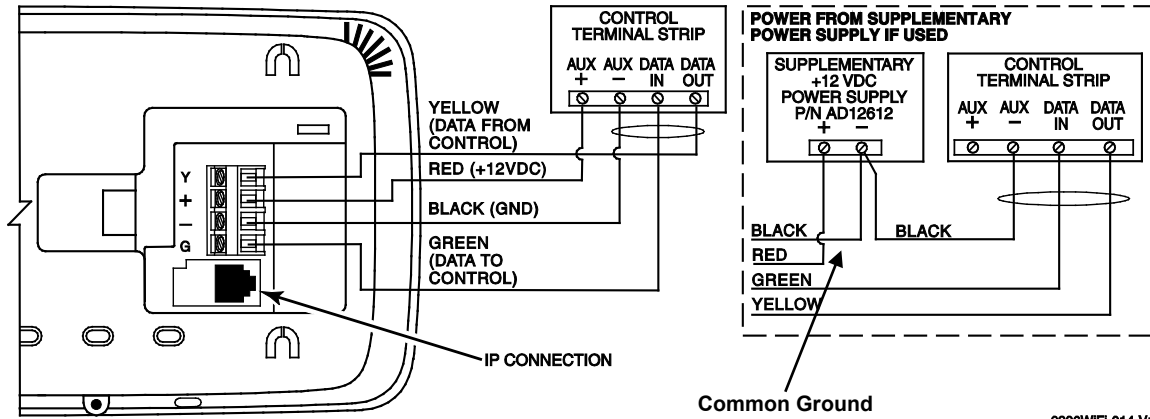

**IMPORTANT NOTES:**

- If an auxiliary power supply is used, you **MUST** connect a common ground as shown above.
- When Tuxedo is powered from an auxiliary power supply, always apply power to the control panel first and then to Tuxedo. Failure to observe this sequence results in improper operation of the keypad and may result in an ECP Error indication.
- Supplementary external power supply must be listed to UL603 for UL Burglary Installations and UL1481 for UL Residential Fire Installations.

**Programming the Control Panel**

**Conventional Programming Methods**

The keypad is not fully operational unless its address in the control panel has been enabled (set as an alpha console) AUI type device, and assigned to a partition (where applicable). For a list of compatible alarm systems, refer to the Control Panel Compatibility for the quantity of keypads that may be used with the Tuxedo and the required control panel's software revision level.

We recommend that you use either a standard alpha keypad or the keypad in Console Emulation Mode when programming the control panel. When in the Console Mode, the keypad emulates an alpha keypad and the programming of the panel is performed following the procedures provided in your panel's Installation and Setup Guide.

**NOTE:**

When programming your control panel, if you change the zone types for your emergency zones you may disable the emergency icons in the keypad. The emergency icons in the keypad are active for zone types 06 (Silent Panic Button), and 07 (Panic Button), 08 (Medical Button), and 09 (Fire Button). Additionally, the Medical button is also compatible with a zone type 15 (24-Hour Medical) for panels that contain this zone type. Review the table under the section **Control Panel Compatibility** for the total number of keypads compatible and the revisions required.

**Residential Control Panels**

Residential Control Panels consist of the VISTA-20P, VISTA-21IP and VISTA-15P and equivalents.

- Addresses one and two (in field \*189) are enabled by default. If the defaults have been changed, enable these addresses (in field \*189) using an alpha-keypad and the Data Field Programming procedures located in the panel Installation and Setup Guide.
- If using Honeywell Total Connect™ Remote Services, here in referred to Total Connect):
  - Honeywell residential control panel revision 9.18 (3.13 for the Vista-21IP) and under must program the Remote Interactive Service option in the second location in \*91 to a 2 (by default location 1 is set to 8, so the entry would be \*91=82)
  - Honeywell residential control panel revision 10.0 (4.21 for the Vista-21IP) and higher supports the RIS option by default, hence there is no programming location to enable.

## Commercial Control Panels (Non-Turbo)

---

Commercial Control Panels consist of the VISTA-128BP, VISTA-250BP and VISTA-128FBP, VISTA-250FBP and 32FBP or equivalent.

- Addresses 1-2, and 3-30 may be used for older controls under revision 10, which supports three AUI's. These addresses in the control panel are not defaulted for AUI type devices. To enable the addresses you are using for keypads, use an alpha-keypad and follow the procedures for "Device Programming" in your control panel "Programming Guide." **NOTE: It is recommended that address 1 is programmed for AUI and one of the keypad is assigned to it.**
- If multiple keypads are being used, they must be set to addresses 1, 2, and X (where X equals any address from three through 30). Only one AUI type device may be assigned to an address from three through 30 on commercial control panels under revision 10.

---

## Vista-Turbo Commercial Control Panels

---

The commercial family consist of the VISTA-128BPT, VISAT-250BPT and VISTA-128FBT, VISTA-250FBPT, 32FBPT or equivalent.

- Any address 1-30 can be used for an AUI keypad, the Vista-Turbo panels can support up to 6 AUI keypads
- If using Total Connect the RIS option must be enabled in the panel. This is enabled by setting the device type to 12 for the address. Refer to the AlarmNet Communicator to determine which address to use (See "Important Notes" below.)

### Important Notes:

- The RIS option **must** be enabled in the AlarmNet Communicator. Failure to do so will prevent control of the automation devices enrolled in the keypad from Total Connect.
- The Keypad should not be assigned as a Master Console. If the keypad is assigned as a Master Console (partition 9), partitions must be controlled from the Partition screen or using the Console Emulation Mode.

---

## Quick Programming (VIP Mode)

---

Tuxedo supports Quick Programming VIP (Vista® Intelligent Programming) mode when used with a control panel that supports this feature. Check the control panels manual to check if it supports this function and for further instructions.

See the "Quick Programming" section for more information.

---

## Data Entry Keyboard

---

Throughout this document, the user is required to enter information on the Tuxedo Keypad (i.e., password, device names etc.) Use the Data Entry Keyboard to enter all required information.

- Press the **Up Arrow** to switch to upper case characters.
- Press the **Space key** to add a space between characters.
- Press the **X** key to delete/backspace.
- Press the **ABC/123** key to switch between numerals and symbols/characters.
- Press **GO** to return to the previous screen.

## First Time Setup

### First Time Power Up (Keypad Initialization)

After first time power up (or a keypad default), the Tuxedo steps through the following setup prompts.

1. Operational Mode Setup
2. “ECP” and “RIS” address selections
3. Honeywell Privacy Statement and End-User License Agreement
4. Wireless Local Area Network (WLAN/LAN) configuration
5. User Setup “Important Operation Information”
6. Remote Login Setup
7. Voice: Disclaimer/Limitation of Liability, followed by a tutorial video
8. Voice Tutorial Introduction

These options can also be set later using the appropriate menus.

**Installer Note:** The Tuxedo touch-screen has been calibrated at the factory. Ignore the “CALIBRATE” icon that appears on the “Options” screen after initial ECP setup. If the screen should require recalibration, the end user may do so via the “Keypad Test” screen. See the “*Diagnostic Tests*” section.

### 1: Operational Mode Setup

#### Languages

The option for English is defaulted and non-selectable. This is there for future updates.

#### Blank Display

The “Blank Display” option is enabled by selecting the checkbox next to “EN50131.” For a list of functions and features of “EN50131,” refer to the “*About the System*” section.

#### Operating Modes

##### Normal Mode

Normal Mode is used for Honeywell security control integration.

##### Safe Mode

The Safe Mode may be automatically entered by the program on a communication failure or may be entered manually on command.

##### To Enter Safe Mode:

1. Select **Safe Mode > Apply > OK**.
2. To exit, press **safe mode bar** press **YES** to return to Normal Mode.
  - While in the Safe Mode, the Home screen displays the Security, Panic, and Message Icon. A message **!SAFE MODE!** is displayed at the lower left side of the screen.
  - Tuxedo resets and restarts in the Safe Mode.

In the rare event that Tuxedo cannot successfully communicate in its graphic mode with the control panel, the Safe Mode is a backup mode that ensures that you can communicate with your system.

In this mode, Tuxedo operates much like a standard non-graphic keypad so that you can control your system until the problem is corrected.

If this situation occurs, Tuxedo presents you with a message of “**Problems detected. Start Keypad in Safe Mode?**” and requests a **YES** or **YES** response. If you answer with **Yes**, Tuxedo enters into the Safe Mode. If you answer with **NO**, Tuxedo tries to communicate with the panel again. After three consecutive times of receiving no response, Tuxedo enters the Safe Mode automatically.

**NOTE:** Use care when providing the “Yes” or “No” response. Pressing the screen outside the prescribed area may cause the background to come to the front. If this occurs, the Yes/No message that disappeared times-out in 30 seconds even though it is not visible. Then Tuxedo resets into the Normal Mode (or Safe Mode if this is the third time that the warning message appeared).

Note that this is a limited mode of operation. While in this mode:

- You can use **Security** to access the Console Emulation Mode of operation to try to clear your faults, disarm the system, or enter additional Alpha Keypad commands specified in your panel User Guide. You can perform almost all functions that you can perform from a standard non-graphic alpha keypad.
- You can press the “Panic” key and generate Emergency Messages as defined in the panel’s home partition for this keypad.
- The Armed and Ready LEDs on the front of the keypad indicates Tuxedo’s home partition status. The Message LED (on models with Voice feature) or Trouble LED (on models without Voice feature) is not active in the Safe Mode.

- The Chime mode functions in the Safe Mode, however, you do not have Voice (system status messages), Voice Chime (announcements) or Message capability (if set to default “Master”).
- Z-Wave Scenes do not function in Safe Mode.
- When an alarm occurs in the Safe Mode, it is displayed on the Console mode screen only and is not shown on the Home screen.
- The Slide Show feature does not start automatically in Safe Mode.

**To Exit the Safe Mode:**

1. Press the **! SAFE MODE !** bar  .
2. Press **YES** to return to Normal Mode. Tuxedo Wi-Fi resets and normal operation returns as long as the original conditions that caused the entry into Safe Mode do not still exist.

**Demo Mode**

Demo Mode allows the automation and multi-media features to operate in a non-security mode for demonstration purposes only.

**Automation (Occupancy) Mode**

This mode is primarily used with the Scenes features to automate certain scene actions and does not communicate with the control panel.

**NOTE:** The Automation/Demo Mode option allows the automation and multi-media features to operate in a non-security mode. When this option is selected, the keypad does not communicate with the control panel and any user can select Advanced Setup screens.

Automation mode allows you to set Tuxedo in two conditions: Residential and Commercial. Scenes can be set to trigger based on the status of these settings:

- In **Residential** mode (default), the Arming options are **Home, Away, and Night**.
- In **Commercial** mode, the Arming options are **Open, Close, and Night**.



**Residential Mode**

From the “Home” screen, press **Setup**  > **System Setup**  > **CS Setup**  > Enter your authorized >





**Options** ; the “OPTIONS and OPERATING MODES” screen is displayed. Highlight the **Automation Mode** check box to enable the option.

To change the occupancy delay time, (the amount of time you want to allow for authorized entry or exit without causing an alarm) select a time interval from the **Occupancy Delay** drop-down list: choose from **15, 30, 60, 120** or **225** seconds.

When done, press **Apply**  to save the settings.

The message is displayed **“WARNING Keypad will reset to activate changes ... Do you want to save changes.”** Select **Yes**  or **No** .



**Commercial Mode**

To enter Commercial mode (automation), from the “Home” screen press following: **Setup**  > **System Setup**  > **CS Setup**  . Enter your authorized code and press **Options** ; the “Options and Operating Modes” screen is displayed.

Highlight the **Automation Mode** check box to enable the option then select the **Commercial** check box.

To change the occupancy delay time, select a time interval from the **Occupancy Delay** drop-down list: choose from **15, 30, 60, 120** or **225** seconds.

When done, press **Apply**  to save the settings.

The message displays **“WARNING Keypad will reset to activate changes ... Do you want to save changes.”** Select **Yes**  or **No** .

**2: Set ECP Address/RIS Automation Address**

Review the panels programming for the proper keypad AUI address.

- If the system is using only one properly programmed Tuxedo (in the control panel), leave the address set to one and press **APPLY**, for more information see the **Programming the Control Panel**. The boot-up process continues until completion.
- If additional Tuxedo keypads are installed in the system, enable each one by assigning it an address, as described above, then power-up each Tuxedo one at a time, and set its address to one of the addresses enabled in the control panel.

## TUXEDO TOUCH WI-FI INSTALLATION & SETUP GUIDE

---

- If using Remote Services, set the RIS Automation Address to the appropriate RIS address used for Total Connect. Only select the Primary RIS Device checkbox if this is the primary device to be enabled and Total Connect will not be incorporated.

**IMPORTANT:** In order for local Z-Wave scenes to function in automation, your Vista system requires a system RIS automation device (keypad or AlarmNet device). If using an AlarmNet Communicator with the RIS option enabled, **uncheck the Primary RIS Device** feature in the Tuxedo. Failure to do so can result in unpredictable results.

Refer to the Control Panel Installation Instructions for additional information.

### NOTES:

1. The Tuxedo ECP address (1-30) is defaulted to one; the RIS Automation address (1-30) is defaulted to 25. The ECP & RIS addresses can also be set later using the ECP Address menu from the CS Setup menu.
2. If “ECP Error” is displayed, the ECP address issue, there is a wiring issue, or **Primary RIS is enabled and it is conflicting with Total Connects RIS feature, see below.** “ECP Error” can be present because of the following:
  - a. Incorrect or conflicting ECP address
  - b. Device programming on the panel has not been configured
  - c. Incorrect wiring, wiring issues preventing data voltage to get to the keypad, refer to the **Wiring** section for more information.
  - d. If using an auxiliary power supply, you must have a common ground from negative on the power supply to the negative on the control panel. Failure to do so will result with “ECP Error.”
3. The default installer code is “4140.” This code is valid from Commercial control panels or if the keypad is in “ECP Error.” Once connected to a control panel, or the ECP Error has cleared, the Tuxedo will synchronize with the Installer Code programmed in the panel. To enter installer level program, after the synchronization, the panel’s installer code will be used.

### Changing the ECP Address

From the Home screen, press **Setup**  > **System Setup**  > **CS Setup**  > enter your **Authorized Code**, if required > **ECP Address**  > Select the **ECP address** for this keypad using the Up/Dn arrows.

### The available ECP addresses are:

**1-2, 5-6:** for VISTA Plus series controls

**1-2, 3-30:** for older commercial controls, under Rev. 10, supports up to three AUIs. **\*See Note below\*.**

**1-30:** for the VISTA Turbo series controls, Rev. 10 and higher, supports six AUIs.

### RIS Automation ECP Address

If using Remote Services, set the RIS address to the appropriate RIS address used for Total Connect. This is programmed in the panel prior the Tuxedo setup. To change the address, perform the following:



Press **ECP Address**  > select **RIS Automation ECP Addr** for this keypad using the Up/Dn arrows. The available RIS addresses are (1-30) and the default is 25.

### NOTES:

- If this is the primary, RIS address (NOT using Total Connect), select the **Primary RIS Device** checkbox and press **Apply.** (**Warning the Primary RIS check box is only for use when Total Connect is NOT used, if Total Connect is used, verify the box is not checked or the keypad may experience undesirable operation.**)
- Also applicable to installations using more than one Tuxedo. Only the primary controller can be programmed as the “**Primary RIS Device.**”

**IMPORTANT:** In order for local Z-Wave scenes to function, your Vista system requires one RIS automation device (keypad or AlarmNet device). If Radio module is setup with Vista panel then it is recommended to leave the "Primary RIS" option un-checked on Tuxedo unit. If Radio module is not setup with Vista panel then ensure only one Tuxedo unit is enabled with the "Primary RIS" option checked.
- If using remote services, one of the touch-screen device (AUI) addresses is used by the control panel. Refer to control panel Instructions for specific configuration.
- On initial setup, the Tuxedo will configure panel data, and then direct you to the Honeywell Privacy Statement and End-User License Agreement.

### 3: Honeywell End User License Agreement (EULA)

The EULA displays and gives you the option to “**Accept**” or “**Remind Me After 2 Hours.**” (NOTE: The Tuxedo requires an acceptance acknowledgement. If not accepted by the third attempt, skipping EULA is no longer an option, only “**ACCEPT**” is available) and the **Wi-Fi Setup** option appears. NOTE: The EULA can be reviewed by selecting **Setup**  > **System**  > **Advanced Setup** .

### 4: Network (LAN/Wi-Fi) Setup

Options are to “**SKIP setup and remind in 2 hrs**” or “**SKIP Wi-Fi setup.**”

#### Enabling the Local Area Network (LAN) Option

By default, the keypad is configured for a LAN connection using a hardwired connection. This option requires the configuration of the Internet Connection Type (DHCP or Static). If static is chosen, the IP Address, Subnet Mask, Default Gateway, and DNS Server is manually programmed by the installer or network administrator. The options are “**Skip Setup Remind in 2 Hrs, Save, or Skip IP Setup.**”

#### Enabling the Wi-Fi Option

Press **WIFI ON**. A pop-up window displays: “**This will switch off LAN Network, do you want to continue?**” **Yes or No**. Use the scroll bar to locate a network from the list of Wi-Fi Networks to connect to and highlight that field. Or, scroll to the bottom of the list and select **Add Network**. Highlight each field to enter the required information for SSID, Security Mode, Passphrase/Shared Key, and Port #. Once “Save” is pressed, the network list screen is displayed and the top of the screen will confirm your connection status by displaying “Connected to XXXX” or “Connecting to XXXX,” where XXXX is the network name.

#### NOTES:

- If “Connecting to XXXX,” continues to be displayed, the Wi-Fi has not been connected and the credentials need to be verified.
- WPS is not a supported feature.

### 5: Important Operation Information

This page collects the user’s data. Enter the data or skip this page to continue to the Tuxedo’s home page. The page data entries are as follows:

Name	Zip Code	Mobile Number	Region	Tuxedo Name	E-mail ID
------	----------	---------------	--------	-------------	-----------

#### NOTES:

- This page can be accessed from the home page by pressing **Setup > System Setup > User Profile**.
- The data for Region and Zip Code/Postal Code synchronizes to the Time/Date setup page if completed during the initial setup. The e-mail address synchronizes to the e-mail setup page, if completed during the initial setup.
- The Zip Code option is needed for accessing sunset/sunrise for your Z-Wave scenes and the weather feature.

### 6: Remote Login

Up to five “User Name” and “Passwords” can be programmed for Local and Remote access using a smart device or computer. The check box stating, “Authentication for Web Server Local Access” will prevent a user the ability to login locally without a user name and password. Failure to enable this option leaves the local access open for anyone with a smart device or computer (and are connected to the same network). The “Secured Web Server Access (HTTPS)” option requires the user to enter HTTPS:// before the remote IP address. These fields are optional and pressing **Finish** navigates to the screen to the voice disclaimer.

### 7: Voice Disclaimer

Pressing **Accept** navigates you to the “Voice Tutorial.” Pressing **REJECT** disables the voice feature and displays the Tuxedo’s home screen.

UL	Voice Input Commands are supplementary only and not evaluated for UL applications.
----	--

**NOTE:** if **Reject** is selected, you will be reminded in 2 hours to review again.

**8: Voice Tutorial and Setup**

Pressing **Accept** at the “Voice Disclaimer” prompt initiate a training video. After the training video is complete, the keypad will walk you through three training learning objectives. These objectives are designed to introduce you to the Voice feature. Once complete, the keypad navigates you to the Voice configuration screen. **NOTE:** The “Voice Setup” screen can be access at any time, from the Home screen press **Setup > VOICE SETUP**.

<b>Command Sensitivity (1-7)</b>	Determines the Tuxedo response to various voice commands in different environments. The options are 1-7, where 1 is the lowest sensitivity and 7 is the highest. Use the Up and Down arrows to change the value to the desired level.
<b>Trigger Sensitivity (1-7)</b>	Determines the Tuxedos response to the “ <b>Hello Tuxedo</b> ” trigger phrase. The options are 1-7, where 1 is the lowest sensitivity and 7 is the highest. Use the Up and Down arrows to change the value to the desired level.
<b>Use System Volume</b>	Select the Use <b>System Volume</b> for normal voice response volume or uncheck the box to use the default (louder) level.
<b>Enable Trigger Feedback</b>	Select <b>Enable Trigger</b> Feedback to enable Tuxedo’s voice response (optional). The trigger phrase is, “Hello Tuxedo.” The keypad displays <b>Microphone</b> (displayed to the right) and waits eight seconds for a command phrase. A message is displayed on the screen along with a voice annunciation phrase “ <b>Hello please say your command</b> ” if trigger feedback is enabled.
<b>Voice On/Off</b>	Enables or Disables the Voice Feature.
<b>Reset to Default</b>	Defaults all customized Voice settings the factory defaults.
<b>Voice Control Video</b>	Introductory and training video for the voice feature.



- Training** Walks through the 3 steps:
  1. “Trigger” then “Command” training – introduces the basic triggers and commands to voice programming
  2. “Trigger + Command” training combined – combines those trigger and commands established in step 1.
  3. “Trigger + Command” training tested five feet away – tests the trigger and command against the environment the keypad is located in. This gives you the option to adjust the settings as needed.
- Log** Lists all the “Detected Voice Commands.” It provides the Date and Time of the command event.
- Counter and Troubleshooting** Interprets the accuracy of the last 10 voice commands based on internal diagnostics. The optimal accuracy is a number between 1-2000. Example:

Commands	Count	Accuracy	Last 10 Accuracy Levels	Clear
Hello Tuxedo	19	1000	3986, 4245, 233, 3085, 2178, 2158, 3099, 2869	Clear
Bed Time	5	1000	675, 1463, 285	Clear
Cameras	2	1000	1661, 1763	Clear
Evening Time	1	100	3735	Clear
Leaving the House	2	1000	3495, 4703	Clear
Returning Home	1	1000	4868	Clear
Wake Up	2	1000	1112	Clear

- If needed, adjusting the “Accuracy” by entering a new value:
1. Find the lowest number in the last 10 commands.
  2. Tap the Accuracy counter number column and enter a number from 1-2000 that is larger than the lowest number shown. For example, if the lowest number shown in the history is 599 set the counter for 800 or if the number is 8055, set it for 900.
  3. If Tuxedo continues to have trouble responding to commands, try entering a higher number. Repeat until you achieve desirable results.

Press **Clear** to clear the last 10 counts and the last 10 accuracy level information, or press **Clear All** to clear the entire list.



**Home Page**

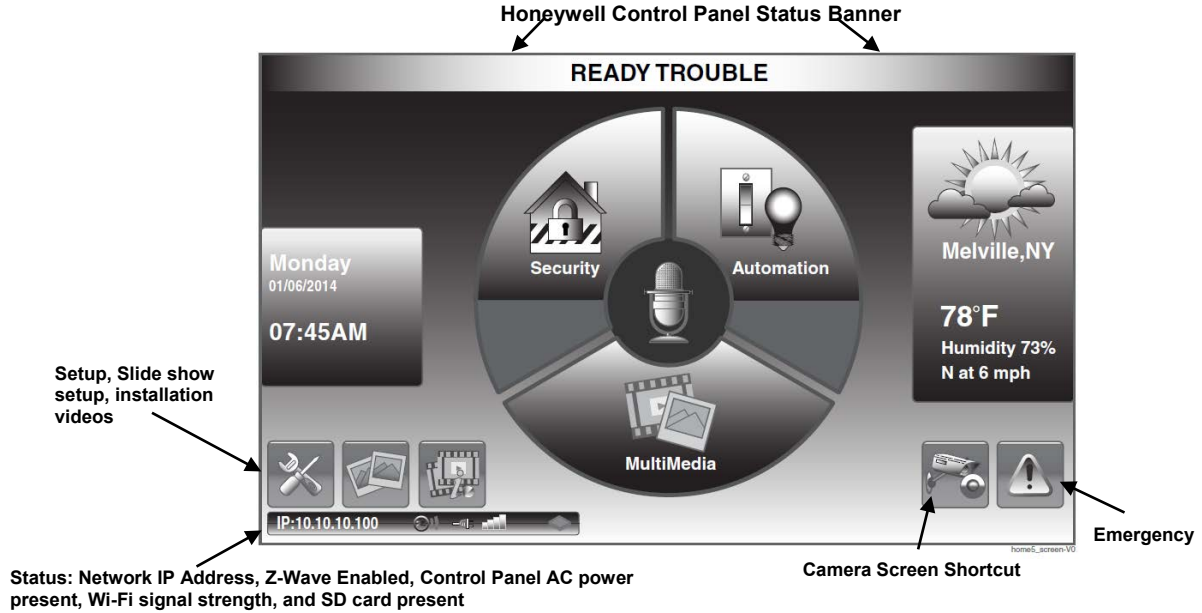

Name	Description
<b>Time/Date</b>	Displays current panels Time and Date.
<b>Setup</b>	Accesses the Setup Menus.
<b>Slide Show</b>	Accesses the Slide Show Setup.
<b>Training Videos</b>	Access to view one of six available videos.
<b>Status Bar</b>	Displays the current Network IP Address, Z-Wave Enabled, Control Panel, AC Power Status of the Honeywell Control Panel, Wi-Fi Signal Strength, and SD Card present.
<b>Camera</b>	Accesses the Camera Screen.
<b>Emergency</b>	Accesses the Emergency (Panic) icons. Can be accessed from any screen.
<b>Temperature</b>	Displays the current temperature.
<b>Security</b>	Accesses the control panel's security options.
<b>Multimedia</b>	Accesses Camera, Event View, Picture, Video, and Message Menus.
<b>Automation</b>	Accesses Lighting (Outputs), Z-Wave device view and control, Scene setup, Room Setup, Z-Wave setup menus.
<b>Status Banner</b>	Displays status of the control panel.
<b>Microphone</b>	No function.
<b>Download</b>	Appears only when a new version of the keypad is available and takes place of the Setup icon.
<b>Download loading</b>	Appears when the keypad is receiving a download from the server.

## Setup Screen

Pressing **SETUP**  from the Home Page reveals the following options:

Name	Description
<b>Brightness/Volume</b>	Move the <b>Brightness/Volume</b> slide bar up or down to increase or decrease settings. Pressing back without saving will present a new window that displays <b>YES</b> saves the change or <b>NO</b> to discard the changes. If <b>Yes</b> is selected when you exit the keypad displays “ <b>Information Settings Saved.</b> ”
<b>Voice Setup</b>	Access the voice configuration screen. See <b>Voice Tutorial</b> above.
<b>Save</b>	After setting the Brightness and Volume to the desired settings press <b>Save</b> .
<b>Partition</b>	No function
<b>System Information</b>	Reveals Software Version, Network Information, Remote Upgrade options
<b>Disp &amp; Audio</b>	Change the Operating Modes of the keypad (Backlight, Slideshow, etc.)
<b>IP</b>	Access the IP Setup menu.
<b>System</b>	Accesses the programming for advance system settings.
<b>Account</b>	Account Log In Username and Passwords (See <b>Web Server Access</b> section for more information).
<b>E-Mail</b>	For configuring email notifications

### System Information



The network information is an important tool. It allows you to verify the Software Version, MAC Address and CRC (Used for Total Connect), IP Address, Broadcast Address, NetMask, and the option to enable the remote upgrade, setup the remote upgrade feature (see “Software Upgrades” section) and syncing the IP to the server.



For Tuxedo to receive an update, it needs to be connected to the internet via LAN or WIFI. An SD card with 200 MB of available space is required.

### Software Upgrades

To view the current software version installed on your system, and verify connectivity, do the following:

Press **Setup**  > **System Info** . The Interface Name, Host Name, MAC Address, CRC, IP Address, Broadcast Address, and NetMask are displayed.

**NOTE:** AN SD CARD WITH 200 MB OF AVAILABLE SPACE IS REQUIRED.

#### Manual Software Upgrades

1. Go to the Toolkit site located at: [www.tuxedotouchtoolkit.com](http://www.tuxedotouchtoolkit.com) to download the latest software to an SD card. An SD card is provided with 4GB of available space.
2. Copy the software upgrade file to the SD card and power down the Tuxedo, or hit **Reset** on the side, under the SD card slot.
3. Insert the SD card > power up the Tuxedo, or wait for the keypad to finish rebooting if **Reset** was pressed.

#### Automatically Pushed Updates



**NOTE:** For Tuxedo to receive an update, it needs to be connected to the internet via LAN or Wi-Fi and an SD card with a minimum of 200MB installed.

#### Automatic Feature Updates

To receive feature updates for non-critical optional features, check the box labeled **Enable Remote Upgrade** on the System Information screen.



**NOTE:** **Setup**  changes to **Available Software Update** . This represents a software download is in process.

#### Optional Software Updates (From Server)

The “Status Bar” will display an  icon for downloading in progress, once complete the **Setup**  icon changes to

Available Software Update  icon. (For the Tuxedo to receive an update, it needs to be connected to the internet via LAN or WIFI.)

The “Home” screen displays the **Available Software Update**  icon, representing there is an update available.

1. Press **Available Software Update** .
2. Press **Software Download**  to view the current software version, the new version, release date and release notes.
3. Press **Install Now** to begin the software update. The screen displays: “**Files downloaded successful...System will reboot in 15 seconds to upgrade the unit,**” or press **Reboot** to start the update process. (Pressing **Abort**. cancels the update.)
4. When the update is complete, Tuxedo reboots and completes the software update.

### Critical Updates

1. Press **Remote Upgrade Setup** to set the period that you want to upgrade the system in the Arm condition.
2. Select the Duration Type in hours or days.
3. Press the duration value to enter the number of Hours (24-1440 hours, default is 720) or Days, (between 1-60 days, default is 30). Press **Save** when done.

**NOTE:** System Critical Updates will automatically be pushed to the Tuxedo, even in the armed state (or in automation mode) upon the time interval set. Example, if a customer is not on site for more than 30 days (default), the system will automatically update and retain the previous system status after the update. System status (armed or disarmed start) will affect this update.

<b>UL</b>	Automatic Push Software Updates are not for UL applications.
-----------	--



## Display & Audio Setup

The **Display and Audio** screen accesses the following options:

### Operating Modes

This screen provides access to **Chime Mode, Voice Mode, and Voice Chime.**

- When in Chime Mode Tuxedo chimes whenever a door or window is open.
- When in Voice Mode the Tuxedo voice annunciates whenever a change in system status occurs such as Armed, Disarmed, or Alarms.
- When in Voice Chime the chime mode and voice mode are in effect. The chime beeps followed by voice annunciation.

Press **Setup**  > **Disp & Audio Setup** ; enter an authorized code, if required > **Chime Mode** or **Voice Mode** (to turn the mode on or off) > **HOME** or **BACK** after making your selection.

**IMPORTANT:** The Chime feature is intended for convenience only, it is not intended for life safety purposes or pool alarms, and does not meet the requirements of UL 2017.

### NOTES:

- If the Chime Mode and Voice Mode are both selected, the Voice Chime is automatically selected.
- When Tuxedo exits the “Operating Modes” screen, your selection is saved.
- It may take a few seconds for the Chime Mode to take effect.
- Certain panels do not support the Voice Chime Mode. Refer to the Control Panel Compatibility section.



## Language Selection (if applicable)

For future use, the Tuxedo only supports the English language.

## Screen Time Outs

- **Backlight Off After X** time (turns the backlight Off after the selected time has expired)
- **To Homepage After X** time (returns to the “Home” screen after the selected time has expired)
- **Auto Slideshow After X** time (if enabled, begins the slide show after the selected time has expired)

To select the desired screen timeouts, do the following:

1. Press **Setup**  > **Disp & Audio SETUP** ; enter an authorized code, if required.
2. Press the desired selection from the drop-down list displaying the amount of time for each option (Never, 30-seconds and 1, 2, 5 and 10 minutes) press **Save**.

If changes are made and press **Save**, a pop-up window displays: “**Information Settings Saved**” and exits to the home page. **NOTE** Pressing **Back** without saving will display “**Aui Setup Changed. Do you want to save it? Yes or No. Yes** saves the changes. **No** discards the change.

## Temperature Unit

---

The temperature units for the weather display on Tuxedo's home screen can be switched between Fahrenheit and Celsius. **Setup > Disp & Audio Setup** and enter an authorized code. Select the temperature scale, **Celsius** or **Fahrenheit**.

---

## Clean Screen

---

With the exception of normal cleaning, the keypad is maintenance free.

Press **Setup > Disp & Audio Setup > CLEAN SCREEN** . A pop-up window displays **"Touch Screen has been disabled so that you may wipe the screen clean. Please use a damp, soft cloth. DO NOT use any liquids, sprays, or ammonia-based cleansers. Press CONTINUE to disable touchscreen."**

**\*Panics cannot be initiated during this process\***

Press **Continue** or **Cancel** to exit or press **Save**.

**NOTE:** When **Continue** is pressed the message **"Touch Screen Disabled for 30 Seconds"** is displayed. During these 30 seconds, the touch screen should be wiped clean of fingerprints using a mild soap solution and a soft cloth. When the counter reaches zero, the window automatically closes and the touch screen is active.

**IMPORTANT:** Do not use an abrasive cleaning agent or abrasive cloth when cleaning Tuxedo or damage to the touch-screen may occur.



The **Emergency** screen cannot be accessed while running in the clean screen mode.

---

## IP (Setup)

---

This section allows you do an initial connection to the Wi-Fi network, or if network change has occurred (i.e. SSID change, Security Mode, or Passphrase/Shared Key). Setting up a LAN (non-Wi-Fi) connection in DHCP mode will automatically populate the required network information (IP Address, Subnet Mask, Default Gateway and DNS Server).

**NOTE:** These fields are not editable. To change the network type to static press the **Internet Connection Type** from Dynamic IP to Static IP. Once, this is done the fields are now editable.

---

## Wi-Fi Setup

---

### DHCP Setup

By default, the keypad is configured for DHCP. Once accessing **IP**, a list of available network will display. Choose the desired network and enter the following information:

Required Field	Description
SSID	Network Name
Security Mode	The keypad will automatically detect the security mode of the router
Passphrase/Shared Key	Password to access the network

---

### Manual Network Setup

---

The option to add a custom network is available by selecting **Add Network**. Connection to this mode requires the information in the "Required Field" column in the table above. Press **Save** when completed.

---

### Static Network

---

The option for a Static Network is only available once you have connected using DHCP, when using a Wi-Fi connection. After connecting to a Wi-Fi network, select the connected network from the list. The next screen reveals the network details. Press the "Internet Connection Type" option to allow the IP Address, Subnet Mask, Default Gateway and DNS Server fields editable.

---

## Port Settings

---

The Port number (**PORT #**) listed on the bottom right corner of the screen is required when port forwarding is being configured. To change the default port number (6280) settings, perform the following steps:

1. Press the numerical value next to **Port #** and enter a secondary port number (between 5000 – 65534).
  2. A pop-up window displays the message: **"Port number changed. Keypad is going to reset."**
  3. At your PC, Smart Phone or Tablet browser, start your browser and enter your IP Address. Refer to the **Remote Access** section for further details.
-

## Webserver Access

### Supported Browsers

System Requirements	Recommended Browser
Windows XP SP2 and SP3, Win7, Win8	IE 8.0 and above, Chrome 30 - 42, Safari 5.0.2 & above, Mozilla 26 and above.
Android Mobile	ICS4.0 and above
iPad™, iPhone™	Default browser (iPhone Version iOS4, iPad® Version iOS4 and iOS5, iOS6)
Android Tablet	Default browser (Galaxy – Android 2.3)
Win 8 tablet	Default browser
Other tablets, smart phones	Might face some issues because it is not possible to support all browsers.

#### NOTES:

- If JavaScript is disabled in any of the browsers then some of the features will not be populate and functions may not work.
- If the “Load Images” option is disabled on a smart device’s mobile browser, then images will not be populate on the pages.
- Google Chrome version 42 and higher do not support the QuickTime plug in; video streaming will not work. This is the same with Android Devices.

**IMPORTANT:** Use the web browser to view cameras for non-security purposes only. Camera streams viewed from the web browser can stop without indication due to network connection issues.

**Internet Explorer 11 Note:** If the video streaming is not working, configure the browser for compatibility mode and refreshed the web page.

### Supported Routers

#### NOTES:

- Tuxedo Wi-Fi is not compatible with Linksys Cisco routers Model: WRT4GL v1.1 Wireless-G broadband router.
- In most cases, IP addresses are assigned ‘automatically’ (DHCP). Alternatively, you may require a “Static” (Fixed) IP Address that can be found by accessing your router. Refer to your router instructions.

Manufacturer Name	Device Name
D-Link	DIR-632 Router
Netgear	WNR2000V3 Router
Actiontec (Verizon FiOS Router)	MI424WR Router
Apple	Apple AirPort Router
Almond	Securifi Almond.
Netgear	Netgear R7000
ASUS	ASUS RTN66U
Netgear	Netgear N900
Netgear	Netgear
Netgear	Netgear
Dlink	Shareport
ASUS	ASUS

## Local Access

Tuxedo’s remote access option offers built-in web hosting capability to access your system via any web enabled device. Tuxedo can connect to a network router via Ethernet cable (LAN network) or via Wi-Fi depending on the installation preference. The **Account Login** menu accesses the username and password used to for the connection. This can be a local connection or remote connection using port forwarding. Features of this page are as follows:

- 5 total users
- Enabling or disabling **authentication for web server local access**
- **Secure web server access (HTTPS)**

## Web Server IP Address Access

The Home screen reveals the connected IP address in the bottom left hand corner. Any device with a browser connected to the same network as the Tuxedo can access the webserver. This does not require authentication (Username and Password). If this authentication is desired, check the **Authentication for Web Server Local Access** check box, which can control who has access to connect by requiring a username and password. Unchecking the box leaves the Web Server open for anyone to connect.



## Connecting the Tuxedo to a mobile device

To connect a mobile device to Tuxedo, view the **Local System Control (Tablet/Smartphone)** training video, and then do the following:

### Smart Phone or Tablet

1. Verify the Tuxedo is connected to the Internet via Wi-Fi or its Ethernet connector.
2. Verify the Smart Phone, or Tablet, is connected to the same network as the Tuxedo Wi-Fi (disable mobile data if needed.)
3. Open the browser and enter the IP Address on the keypad (described above).

### On a Personal Computer (PC)

1. Verify the Tuxedo is connected to the Internet via Wi-Fi or its Ethernet connector.
2. Verify the PC is connected to the same network as the Tuxedo Wi-Fi.
3. Open the browser and enter the IP Address on the keypad (described above).

### Remote Access Browser Commands

Access to basic arming commands is available if using a Smart Phone or Tablet browser. Full access to keypad options is available if using a PC.

#### NOTES:

- If left inactive, the web connection will disconnect after 10 minutes.
- If using an iPad, iPhone or PC browser with low bandwidth on the mobile PC type theme, switch to the mobile

theme. To switch to the mobile theme press **Switch Theme**  in the lower left hand corner.

Not supported commands during remote or local access with a web browser in PC or Mobile Modes:

<b>Security</b>	Annunciate status System troubles Emergency button Event logs Show zones	<b>Multimedia</b>	Message center Picture/slide show Camera 360 degree rotation Camera Wi-Fi settings Recording settings
<b>Automation</b>	Z-Wave device management Emergency button Rooms Remote scenes	<b>Setup</b>	Account setup Disp. & Audio setup IP setup System setup Email setup Voice setup Remote firmware upgrade
<b>General</b>	Weather Training videos		

## Local Web Server URL Access

In cases where the Tuxedo is set for DHCP, there is the possibility the IP address can change upon a router reset. This can block the users attempt to access the Web Server locally. To correct this problem, navigate to the “Address Box” of the browser and type in [HTTP://Tux.MyLanConnect.com](http://Tux.MyLanConnect.com). The browser will display the following information:

Description	MAC Address	Device Name	Internal IP
TUXW_XX.XX.XX	00D02DXXXXXX	Master Bedroom Keypad	192.168.1.120
TUXW_XX.XX.XX	00D02DXXXXXX	Garage Entry Keypad	192.168.1.110
TUXW_XX.XX.XX	00D02DXXXXXX	Front Door Foyer Keypad	192.168.1.112

### Troubleshooting

If the page does not populate, from the Home Screen press **Setup > System Setup > System Information**.

1. Press **Sync IP to Server**.
2. The message **“System IP sync to server is successful,”** when a successful connection is made.
3. If no connection is present, the message Keypad is not in the network. Please check the network connectivity.”
4. If the keypad is connected to the LAN with no internet access, the message **“System IP sync to server has failed”** appears.

If Authentication for Web Server Local Access is enabled, and no user name and password is created, the browser will produce the following message: **“Warning Remote access has been deactivated. Go to your Tuxedo’s login setup to create an account for remote access.”**

### NOTES:

- To correct this add a username/password and verify the user is enabled.
- Browser may block access if the Secured Web Server Access (https) option is enabled. During remote login, if the browser displays a Security/Certificate Error (see examples below) this is not a threat and it is recommended that you continue.

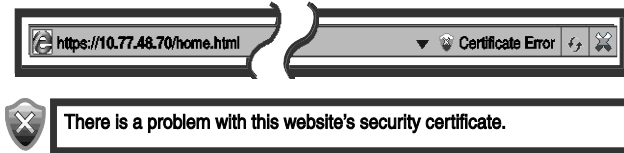

## Remote Access Using Port Forwarding

Tuxedo offers built-in web hosting capability to access your system via any web enabled device. The local IP Address is used on a standard web browser to control user functions. The home router must first be configured for port forwarding for both HTTP and HTTPS ports, which port the local IP address. Refer to the router’s instructions for details on Port forwarding. See the notes above for any security certificate errors and steps to be taken to proceed.

### Remote Access Log In Setup (Account Setup)

The home router must first be configured for port forwarding for both HTTP and HTTPS ports. Refer to the router’s instructions for details for instructions concerning port forwarding.

You can assign up to five user logins. The Tuxedo can determine when there is a local or remote (port forwarded) session. If determined it is a remote session a username and password are required

To set up a remote access log in, do the following:

1. Press **Account Setup**.
2. Enter the desired user name and password.  
**NOTE:** Passwords must be eight alphanumeric characters, include at least one uppercase letter and one number.
3. Check the box for **Secured Remote Access (HTTPS)** (optional) > **Save**.  
A confirmation window displays the message, **“Settings Saved.”** The new user is displayed along with an **Enabled** button, if there is no network connection the icon will change to **Disabled**.
4. To clear a user’s login, press **Clear**.

### NOTES

- Remote login is blocked after three failed attempts. To restore, on the keypad click **Setup > Account**, press the appropriate user **Disabled** icon > **Save**.
- If left inactive, Web connections disconnect after 10 minutes.

## Email Setup

---

Email notifications allow you to set up email accounts and receive email notifications when one or more system events occur.

Users (and/or the installer) can receive email notifications when one or more selected system events or conditions occur

**NOTE:** Email notification requires that the user has an active email address and note the disclaimer at the bottom of the page. ***“Email notification is strictly for convenience use only. Avoid relying on this feature for life critical events. It is not UL certified and may fail at any time without notice.”***

### NOTES:

- Email notification requires that you have an active email address.
- An SMTP account needs to be assigned to establish the email server domain (i.e., the “from” address).
- Four programmable sets of events (labeled “Event 1 – Event 4”).
- Each event 1-4 can send email notifications to up to four email addresses.
- Seven event types and corresponding conditions can trigger an email.



For each event 1-4, choose the conditions that will trigger notification:

-

---

## User Email Setup

---

1. To set up an email notification, from the Home screen, press **Setup**  > **Email** .
2. Select the **User SMTP** icon to set up the user’s email server information (user domain/server, which provides the “from” email address).
  - a. Select the email server name (email provider). Choose from **GMAIL, OUTLOOK, YAHOO**, or **Add New E-mail Server**.
  - b. Enter the **Email ID (Username)** and **Password** for the chosen email server on the appropriate lines.
  - c. The Email Server and SMTP port number fields are automatically filled unless “Add new email server” was selected.  
If **Add new E-Mail Server** was selected, enter the email server SMTP and port number information (see your email provider for details).  
To change the “E-Mail Server Name,” press **Edit**  and enter a new server name.  
Enter an “E-Mail ID” and password. Enter the “E-Mail Server” address and “SMTP Port Number.” If required by the e-mail service provider, click on the box next to **USE SECURE CONNECTION (SSL)**.
  - d. Press **Save**.
3. Press **Event 1** to define the desired event notifications to be sent (See “Defining Event Types” section below.) Select the desired event types and conditions for this Event and press **Save**.
4. Enter the email address(es) to which Event 1 will send a notification; press **Save** when done. User notifications are restricted to one SMTP (from) email address.  
Repeat steps three & four for Events 2-4 if desired.
5. Press E-MAIL LOG to view the email log; press **CLEAR LOG** to remove the email log.

### Dealer Notifications (Automation Mode Only)

If Dealer notifications are desired, press **Dealer Setup**  to assign the “Dealer Email.” “Dealer SMTP” and “Dealer Code” then follow the steps above to program event notifications. Dealer notifications are restricted to one email address. **NOTE:** Dealer Notifications are only accessible when keypad is configured in “Automation Mode.”

### Dealer Code

Press the **Dealer Code** icon and enter the **New Code; Confirm New Code** and press **Save** when done.

The dealer can choose to save the Dealer Email and Dealer SMTP to the SD Card by selecting **Save conf to SD Card**.

The dealer can use the SD Card with the saved configuration and apply to another keypad by selecting **Load conf from SD Card**. Press **Save** when done.

---

<b>UL</b>	Email Notifications are supplementary only and not evaluated for UL applications.
-----------	---

---



## Defining Event Types

To receive email notification when specific events occur, the “event type” must be defined. Scenes can be set to trigger based on the status of these settings. From “System Events Notification” screen, set the following event types:

Event	Definition
Security	(Normal mode; current home partition only.) Press the desired check box next to <b>Disarm, Arm Away Secured, Arm Stay</b> and/or <b>Alarm</b> .
Zones	(Normal mode; current home partition only.) Press the desired check box next to <b>Alarm, Trouble,</b> and/or <b>Restore</b> .
Occupancy (automation mode only)	Press the desired check box next to <b>Home, Away</b> and/or <b>Night</b> . <b>NOTE:</b> If in Commercial mode, the occupancy options are <b>Open, Close, and Night</b> .
Thermostat	Select a thermostat from the drop-down list. Press the desired check box next to <b>TEMP ABOVE / TEMP BELOW</b> . Enter the temperature degree that triggers an Email when the temperature rises above or falls below the set point.
Door Lock	Select the desired door lock from the drop-down list. Press the desired check box next to <b>UNLOCKED</b> and/or <b>LOCKED</b> .
Garage Door	Select the desired garage door from the drop-down list. Press the desired check box next to <b>CLOSED, OPENED</b> and <b>OPERATION DISABLED/FAILED</b> .
Water Valve	Select the desired water valve from the drop-down list. Press the desired check box next to <b>OPENED</b> and/or <b>CLOSED</b> . <b>WARNING:</b> The Leak Gopher® water valve does not send status to the keypad when operated manually. It is not recommended to select this device as an Email trigger.
Recording	Select an Email address and highlight <b>Recording</b> . Enable the desired check box next to “ <b>On Event Recording</b> ” and/or “ <b>SD Card Memory Full</b> .” <b>NOTE:</b> An SD Card Full Message displays when 90% of the usable space on the SD card is used.

**NOTE:** An SD Card Full Message displays when 90% of the usable space on the SD card is used.

## Troubleshooting



- If an error is returned through the listed SMTP email provider stating that the email has blocked a sign in attempt, return to the SMTP server page and verify the email settings. The Tuxedo will populate an error that states “**Warning: Email sending failed. Please check SMTP settings.**” If this is the case, check the security settings for the email chosen through the provider.
- The customers email server may see a frequently sent message and could perceive it as a threat. The result is the email provider will lock down the email receive and send. You will have to contact their email provider to resolve.

## System Setup

The System menu is comprised of the following options:

Menu	Description
<b>Controller Initial Set</b>	Walks through the initial setup (same as first time power up or keypad default). See the “First Time Setup” section.
<b>Quick Programming Setup</b>	Installer menu programming (vs. using console mode)
<b>Tuxedo Sync</b>	An advanced Z-Wave function (See the “Z-Wave” section)
<b>User Profile</b>	See “Important Operation Information” section for more details
<b>CS Setup</b>	Installer level Setup and Troubleshooting tools
<b>User Setup</b>	Setting up User Codes with the Tuxedo
<b>Advanced Setup</b>	Access to advanced Installer/User options
<b>Time/Date Setup</b>	Configure the time and date
<b>Power Mode Setup</b>	Program how the keypad reacts during a power outage

### Quick Programming

The Quick Programming section gives the installer options to program the basics of the control panel. To access Quick select the **Quick Programming** button: the screen displays a **Confirmation** message **“Not every security panel supports quick programming. Check the panel's documentation to make sure it supports quick programming. Choose Abort if the panel does not support it or Continue to enter quick programming. Choosing Continue on unsupported panels may result in this device resetting.  Continue or  Abort.”**



Select **Continue**, and then enter an authorized code. An **Information** message is displayed **“Panel is entering programming mode, please wait...”**

- Follow the menus and prompts to program the control panel.
- Only the residential panels support the Quick Programming mode.

### Quick Programming Menu's



Menu	Programming Locations
<b>Phone Account</b>	Primary and secondary phone and account number for partitions 1 and 2.
<b>Reporting</b>	Select Yes or No for Alarm Restore, Trouble, Bypass, AC Loss, Low Battery, Test, RF Low battery, or select <b>All</b> to enable all events.
<b>System Reports</b>	RF Jam, Log Full, Open Report, Close Away, Close Stay, Cancel, Exit Error, All.
<b>Timing &amp; Misc</b>	Exit Delay, Entry Delay 1, Entry Delay 2, Installer Code, Auto Stay, Alarm Sound Time, and Fire Sounder Time Out.
<b>Zone Programming</b>	Send Report, Input Type, Library (Vocabulary), Part (Partition), Resp (Response Time), Config (Hardwire Type).

## CS Setup (Central Station)

- Menu** Programming Locations (Press **Setup**  > **System Setup**  > **CS Setup** ; enter the Installer Code)
- ECP Address** Configure the Tuxedo ECP and RIS address (see the “2: Set ECP Address/RIS Automation Address” section).
- Options** The configuration options are:

Options	Description
<b>Lighting</b>	Unchecking the box will eliminate the output control for the panel option, located under “Automation.” Leaving it checked enables the option, see “Output Setup Function”
<b>EN50131 Display</b>	See the “Blank Display” feature under the “About the System” section for more information
<b>Weather Forecast</b>	Unchecking the box disables the Weather Forecast from the home page. For setup instruction, see the “Weather Forecast” section.
<b>Commercial</b>	Only available in Automation Mode. See the “1: Operational Mode Setup”
<b>Operating Modes</b>	Options are <b>Normal Mode</b> , <b>Safe Mode</b> , <b>Demo Mode</b> , and <b>Automation Mode</b> . See the “1: Operational Mode Setup.”

**Code Authority** The Code Authority screen displays User Names and Partition Authority Level for the User Code. To view the Code Authority level, do the following:



Press **CS Setup**  > enter authorized code > **Code Authority**  > Enter the 4-digit User Code for the user that you want to obtain Authority Level information about > **BACK**.

**NOTE:** If the User Code entered is not active in the system, an **INVALID** message will be displayed. Tuxedo has the ability to record events in a history log. Each event is recorded with the time and date of its occurrence.

**Device Events** Press **Device Events**  and a list of events is displayed.

To view a record of events in a history log, slide the scroll bar down. The Date, Time and Description of each event is displayed.



## Time/Date Setup

If not already set from the control panel, set the current time and date using the **Time/Date Setup** menu access by pressing **Setup** > **System Setup**  > **Time/Date Setup** . When the time is set it is stored in Tuxedo, it is sent to the control panel when you press **Apply** and answer **Yes**. Additionally, when using the Tuxedo, the panel may download its time into Tuxedo periodically after the clock is set (for Vista Plus series and newer commercial panels such as Vista Turbo series).

Pressing **Get Time** downloads the time, date from the control panel, and exits the Set Time & Date screen.

**NOTE:** This  with VISTA Plus series controls and may not appear with all VISTA Turbo controls.

To set the current time, do the following:

1. Press **Time/Date Setup**  and enter your Authorized Code.
2. Press the **Month** "drop down," and select the current month.
3. Press the displayed **Year / Hour / Minutes** and enter the current year/hour/minute(s). Select **AM** or **PM**. (Each depression toggles the AM/PM display).
4. Press the **MMDDYY** "drop down," and select a format for which you want the date to be displayed.
5. Select a 12-hour or 24-hour format for your time display by checking the box to the left of the **12 Hour** display. **NOTE:** Checked sets it for 12-hour format, unchecked sets it for 24-hours format.
6. Press **DST**  to enable daylight saving time in your system clock. Set the “Start DST” time and then the “End DST” time by selecting the appropriate **Month**, **Weekend** and **Hour** that DST starts and ends.
7. Press **Apply** , a confirmation screen appears. **Yes**, saves the time changes in your security system. **No** saves the changes to the Tuxedo only.

**NOTES:**

- A **Yes** response is recommended.
- Getting time from the internet feature is only supported in **Automation Mode**.
- After each selection, the window closes automatically and the selection is displayed.

**User Codes**

Each user must be assigned a name with a corresponding 4-digit user code in order to gain access to various features and functions. Tuxedo can hold the identity for 10 Users in its memory. If additional Users are needed, define the additional Users using the Console Emulation Mode.

Users for the system are programmed in a central user setup location that provides the specific questions for authorization levels assigned to different users. You may want these users to be the same, but there are situations in which you may want a user to have limited capabilities. These capabilities are defined by the Authority Level assigned to each user.

**Authority Levels**



Authority levels define the system functions a particular user can perform. Depending on the authority assigned to you, there are certain system functions you may be prohibited from performing. The following information describes the authority levels available in Tuxedo and provides the equivalent authority level name found in your alarm system manuals. The authority levels available in Tuxedo are as follows:

Keypad Authority Level	Functions	Equivalent System Name	
		Residential Systems	Commercial Systems
<b>Installer</b>	Can perform all security functions except can only disarm if code was used to arm, can change Master Code, cannot change other user codes, can access the Central Station Screen options. <b>NOTE:</b> This authority level cannot be assigned using the keypad.	Installer	Installer
<b>Master</b>	Can perform all security functions, add/delete users in assigned partition, program scheduled events, and change partition master code.	Partition Master	Level 1 Master
<b>Normal</b>	Perform security functions (arm, disarm)	Standard User	Level 3 Operator A
<b>Guest</b>	Can arm the system in assigned partitions, but cannot disarm the system unless the system was armed with this code. <b>Note:</b> Do not assign this level if Quick Arm is enabled in the system.	Guest	Level 4 Operator B
<b>No Access</b>	Used to restrict access to a partition.	N/A	N/A

**NOTE:** The authorized code for deleting, adding, and editing users is dependent upon the interfacing alarm panel. Check your alarm panel *Installation and Setup Guide* to determine who can delete, add, and edit users.

**Add a User**

From the "Home" screen, press **Setup**  > **System Setup** .

1. Press the **USER SETUP**  > **ADD USER**  > enter your authorized code. Press the box next to **Enter User Name** and type in the user name (max. 6 characters; no spaces between characters) press **OK**.
2. Press the box next to **User Number** and enter an "available" (3-digit) user number; press **OK**.
3. Press the box next to **Enter User Code**, enter the 4-digit User Code for this user and press **OK**.
4. Press the box next to **RF Button Zone** (if used); enter the 3-digit RF Button Zone for this user.
5. Press **Save**.

**NOTES:**

- For available user numbers, refer to the control panel instructions.
- If assigning this user to wireless key, enter one of the zone numbers of the keyfob (the wireless key must be programmed first before it can be assigned to a user).
- Each user programmed by an authorized code (in most cases, this is user two in most cases.) This means that user two (or whichever code you are using to program the users) cannot be assigned to a user in the keypad.

## How to Add an Existing User to a Second Tuxedo

After adding a user to the first Tuxedo, the same user can be added to a second Tuxedo. From the second Tuxedo go to **User Setup** and enter the same user name and same user code (refer to “How to Add a User” above). The second Tuxedo will automatically update the user information. Press **Save**.

## Delete a User





Select the User you want to delete and press **DELETE USER** . Enter your authorized code, and press the appropriate icon.

## Edit a User

**NOTE:** You cannot edit a User name or User number. To modify a User name or User number, you must delete the User and re-enter the User. Edit a User as follows:

Press **EDIT USER**  and enter your authorized code. Select the options needed for this user and press **Save**.

## Advanced Setup

Access these menus from the **Home** screen, press **Setup**  > **System Setup**  > **Advanced Setup** . If applicable, enter your authorized code and press **Keypad Test** .

Keypad Test lets you verify correct operation of the Tuxedo and its connections to the security system. There are five diagnostic tests:

- **LCD Display Test**
- **Audio Test**
- **LED Test**
- **Calibration**
- **Z-Wave Test**

**NOTE:** Performing Diagnostic Tests: Select any diagnostic test from the “**Diagnostics**” screen by pressing its associated **Test** icon. All or any individual test may be run when you access the “**Diagnostics**” screen; however, each test must be performed one at a time. At any time when a test is not being performed, you can press back to return to the previous screen or home to return to your home page.



Once the Diagnostics screen is exited, subsequent entry to this screen displays all test options as “Not Performed.”

## LCD Display Test

Press **LCD Display Test** ; a series of screens appear.

After each type of display, you are asked if the display was proper. If the response to all questions is yes, the LCD Display Test message area of the Diagnostics screen displays **Passed**.



The **Emergency** screen cannot be accessed while running the LCD Display Test.

## Audio Test

Press **Audio Test**; **Testing...** is displayed while beeps sound from the speaker. At the conclusion of the test, a pop-up “Confirmation Window” is displayed with the question **Did you hear Beeping?**

- When you press **Yes**, “**Passed**” is displayed in the test status column on the “Diagnostics” screen.
- When you press **No**, “**Failed**” is displayed in the test status column on the “Diagnostics” screen.

## LED Test

Press **LED Test**; “**Testing...**” is displayed while the 3 LEDs light sequentially, top to bottom (red, green, yellow), 5 times. At the conclusion of the test, a pop-up “Confirmation Window” is displayed with the question “**Did you see chasing LED pattern?**”

- If you press Yes, “**Passed**” is displayed in the test status column on the “Diagnostics” screen.
- If you press No, “**Failed**” is displayed in the test status column on the “Diagnostics” screen.

## Calibration

Press **Calibration** and using a stylus, follow the screen directions by pressing a series of crosshairs (+) and boxes (□) on the screen until done.

If the test was successful, press **OK**, the screen returns to the Keypad Test screen.

A pop-up message displays **Touch screen calibration... Touch crosshair to calibrate.**

If the Calibration Test was successful, a confirmation screen appears stating:

**Congratulations Calibration Success**

If the test was unsuccessful, an error message appears stating:

**Calibration failed, do you want to retry? Yes or No.**

## Z-Wave Test

**This procedure is for Z-Wave test purposes only.**

Role shifting is the process of shifting primary and secondary keypads (controllers). The secondary controller becomes the primary controller with the ability to enroll Z-Wave devices. This is useful when the primary controller is in a fixed location and the Z-wave device is not easily accessible (but within

Z-Wave range). To perform the role shifting Z-Wave Test, do the following:

Press **Z-wave Test**. Select from two main categories of tests:

- **Z-Wave Role Shifting:** Primary Controller shift to Secondary and Secondary Controller shift to Primary.
- **Z-Wave Basic Command:** Set On or Off.
- **Assign Router:** Manually assign new Z-Wave routes.

With the status of the controller in the “P” (Primary) state, press **Z-Wave Primary**.

### Controller Shift to Secondary.

To shift the primary controller role to a handheld controller (software or second Tuxedo); follow the controller manufacturer’s instructions.

1. Press **Z-Wave Primary Controller Shift to Secondary** on the primary Tuxedo (or software, hand held device when shifting role back to the Tuxedo.)
2. Press **Z-Wave Secondary Controller Shift to Primary** on the secondary Tuxedo (or software, hand held device) to shift role from the secondary Tuxedo.)



A pop-up window is displayed with the following **“Role Shift is in progress, please wait ...”**

**This Z-Wave controller shift function is for evaluation only now. This primary controller is shifting to the secondary.**

The shift is completed when the pop-up window disappears.

When the pop-up message disappears and controllers have shifted successfully, Z-Wave devices can be enrolled from this controller. Once complete, shift the Tuxedo back to the primary controller after enrolling Z-wave devices.

### NOTES:

- The status of the controller can only be changed from **Primary**  to **Secondary**  controller when no devices are enrolled. Use the delete device or reset controller function to remove enrolled devices.
- **Z-Wave Primary Controller Shift to Secondary** is inactive when the Tuxedo keypad becomes the secondary controller, and the same when shifting roles again.

Select **Z-Wave Basic Command Set On** to turn on all lamp modules, dimmer On/Off switches and receptacles.

### NOTES:

- This command does not control door locks, garage doors, or any other security enabled devices.
- This test may cause lights and thermostat settings to change.

Select **Z-Wave Basic Command Set Off** to turn Off all lamp modules, dimmer On/Off switches and receptacles.

**NOTE:** This test may cause lights and thermostat settings to change.

### Assign Router

This option gives you the ability to change the route from one device, through a repeating device (router), to the next device. This is useful for troubleshooting problematic devices. The screen displays:

		Box 1	Box 2	Results
Default Display	Assign Router	2	3	Test Result
Press <b>Box 1</b> > enter the first device in <b>Box 2</b> > 	Assign Router	2	5	<b>Transmit Start</b>
Success full route change displays	Assign Router	2	5	<b>Transmit Complete</b>
Unsuccessful route change displays	Assign Router	2	5	<b>Transmit no ACK</b>

## Keypad Reset

Press the **Keypad Reset** ; the message is displayed “*Confirmation Are you sure you want to reset?*” Select **Yes** or **No**.

**NOTE:** This is **not** a factory default, but simply an option to reboot the keypad.

## End User License Agreement (EULA)

To review the EULA, you can choose “End-User License Agreement.”

## Factory Default

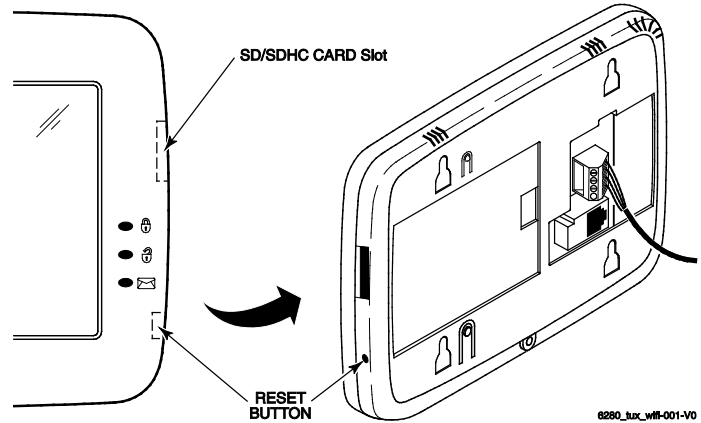

To return the keypad to factory defaults, press the following **Factory Default**. The message displays, “*Are you sure you want to restore the Tuxedo device to factory defaults? All settings will be erased and the keypad will reset!*” If **Yes** is selected, Tuxedo reboots and reverts to factory default settings.



This does not default any installed Z-Wave devices, but does remove their names and any scenes, groups and rooms that may have been created. Write down the names of each device and the configuration of each scene and detailed information about the groups and rooms.

## Output Setup

Tuxedo can activate/deactivate up to 18 pre-defined control panel output functions (if programmed in the control panel). The Output Setup screen displays Output selections. Control these output functions by enabling/disabling as follows:

Press **Output Setup**  > select the outputs to display or not display on the Output screen > **Apply** . A confirmation window displays **Information Settings saved**. Press **OK** to save the setting.

If the **Back**  is pressed, a confirmation window displays “*Output Settings changed. Do you want to save new settings?*” Select **Yes** or **No**.



**NOTE:** This is a local setting for the graphic keypad. If user has the maximum number of keypads on the system, and wants to disable the same output for all, each Tuxedo needs to be set individually.

## Night Setup Function

The **NIGHT** function can be set to arm the system in one of five arming modes:

- **Away** - Arms all zones with entry delay.
- **Stay** - Arms perimeter zones with entry delay.
- **Instant** - Arms perimeter zones without entry delay.
- **Night** (Residential Panels Only) – Arms all perimeter zones. All interior zones are also bypassed, except for those zones programmed in zone list five.
- **Maximum** - Arms all zones without entry delay. Not to be used for ANSI/SIA CP-01 installations.

To set the **NIGHT** function, do the following:

Select the arming mode to be activated when **NIGHT**  is selected on the "Arming" screen. **Apply**  accepts the setting. **Back**  cancels your selection.

## Power Mode Setup

---

Power Mode allows you to reduce power consumption in the event of a system trouble such as AC Loss or Panel Low Battery.

Select **Power Save Mode** to enable; then choose Turn-off Network, or Override Display Settings.

Press **Apply**  to save settings.

### AC Loss Notes

When **Override Display Settings** is selected, Display settings are overwritten and Tuxedo operates in **low power mode**:

- Brightness/Volume controls decrease to minimum levels.
- Return to Homepage After time resets to 30 seconds.
- Auto Slideshow After time reverts to Never.
- When AC power is restored, the original Display settings resume.
- The device will disable the Network if it is configured.
- AC loss changes are not supported in safe mode.

## Multimedia

---

### Picture & Slide Show Setup

---

Tuxedo can display personal photo(s) on the Home screen as wallpaper or in a slide show format. To set up a slide show of pictures, do the following:

1. Insert your personal media (SD/SDHC) card (with stored picture files). Formats supported are .bmp, .png or .jpg files.

2. From the Home screen, press **Multi-Media**  > **Picture** . The first image is displayed and a list of stored images appears on the screen.

### Slide Show Setup

1. To add an image to the slide show, select the image from the list and press **Add Image** ; the image appears on the screen and a check mark appears next to the selected image name on the list.

2. Press **Slide Delay** arrow to select the time interval that you want to allow between each photo being viewed. Choose from (5, 10, 15, or 20 seconds).

3. Press **Transition** arrow to select the type of viewing transition desired (Standard, Horizontal, Vertical or Fade Out).

4. After images have been added, press **Play Image**  to begin the slide show.

To remove an image from the slide show, select the image, and press **Deselect Image** .

5. To navigate to the **Next Image** press ; to go back to a **Previous Image** press .

### New Wallpaper Setup

1. Use the slide bar to highlight the file (image) you want to be displayed on the keypad screen.

2. Press **Set Wallpaper** ; view your selection from the “Home” screen.

Press **TOP** to move up one level in the directory.

Press **OPEN** to view larger images and/or open directories, select from the list of images.

Press **CLEAR ALL** to clear all pictures from the current slide show rotation.

### NOTES

- To exit the slide show at any time and resume normal operation, press anywhere on the screen.
- When an image is loading, no other Picture Setup function can be performed.

---

**UL**

Multimedia functionality is supplementary on and has not been evaluated for UL compliant applications.

---



## Camera Options and Setup

The access the camera setuppage press **Multimedia**  > **Camera View/Record**  > **Camera Setup** .









**NOTES:**

- Keypad must be connected to same LAN or Wi-Fi network as the cameras, before they can connect.
- View the “IP Camera Setup” training video for helpful information to aid in the setup.
- Supports up to 32 cameras with up to four cameras viewable at one time.

**NOTES:**

- QuickTime® media player must be installed on your PC.
- Camera viewing is compatible with IE8 (and above) and Safari 5.0 (and above); and not compatible with Opera web browsers or Chrome version 42 or above.
- Some older versions of these cameras may need a firmware upgrade; see separate instructions.
- The cameras will appear in a Quad View mode, however, you can select icon in bottom right corner for single view.

 Use the web browser to view cameras for non-security purposes only. Camera streams viewed from the web browser can stop without indication due to network connection issues.

Icon	Name	Description
	<b>Camera Discovery</b>	Discovers all cameras with UPNP Enable
	<b>Add Camera</b>	Manually add a camera
	<b>Edit Camera</b>	Edit existing camera
	<b>Delete</b>	Delete a selected camera
	<b>Delete All</b>	Delete all camera's
	<b>Camera Settings</b>	Review the camera's current setting
	<b>Camera Wi-Fi</b>	Changes the selected camera from LAN to Wi-Fi
	<b>Recording Settings</b>	Adjust the recording settings for each camera

## First Time Setup

Scan and configure the cameras prior to mounting; follow the steps below:



1. Connect an Ethernet cable to the back of your camera (LAN); connect the opposite end to the Ethernet Port on your router (or HONEYWELL-WAP, as long as it is connected to the router). Apply power to the Camera. Wait 60 seconds for initial power-up of camera.

**NOTE:** A LAN connection is initially required, once the camera is configured with the **Camera WIFI**  option it will change if from a LAN to Wi-Fi connection.

2. Press **Discover**  to locate cameras. The screen displays: “**Discovering Cameras Please Wait...**” Repeat this step until all cameras are discovered.

**Notes:**

- All devices enabled for UPNP (Universal Plug and Play) will be discovered.
- Delete the unwanted devices.  
The Tuxedo will do a 24-hour refresh (to make sure the IP address has not changed.) The deleted devices will not populate again during the 24-hour refresh.
- If new cameras will not discover, you can manually enter or wait for the 24-hour refresh.

3. To edit information, highlight the camera name and press **Edit** . Highlight each field and enter the required information (see Add/Edit Options below), and then press **Save** .



To retrieve camera settings and connect to the camera, press **Connect** .

**Add/Edit Options**



If the camera information is not discovered automatically, press **Add** to enter information on the “Add New Camera” screen.

Name	Description NOTE: Must be alphanumeric only, no special characters (including space) are compatible.
<b>Camera Name</b>	Default is the Camera Model (abbreviated) X, where X= The Mac <b>NOTE:</b> Maximum # of cameras supported.
<b>Camera IP Address</b>	This is the address of the camera, which is assigned by the router
<b>MJPEG Streaming URL</b>	Fixed
<b>RTSP</b>	(Real Time Streaming Protocol) Port #. Select ports (554, (1024-65534))
<b>Resolution</b>	(Options are 160x120, 320x240, 640x480) Select from 160 x 120, 320 x 240 or 640 x 480. For best performance set video resolution to 320 x 240, 8 frames per sec. <b>NOTE:</b> <ul style="list-style-type: none"> <li>• Model iPCAM-WL resolution is fixed at 320 x 240 or user can change to 640x480.</li> <li>• When setting the resolution to 640 x 480, the recommended frame rate is eight frames per sec.</li> </ul> When setting the resolution to 320 x 240, the recommended frame rate is no more than 15 frames pre sec.]
<b>Camera Model:</b>	Select iPCAM-WI, iPCAM-WI2, iPCAM-WI2B (black), iPCAM-WO or iPCAM-PT, WVC210, iPCAM-ACU, iPCAM-WL, ONVIF, Trendnet, and others. <b>NOTE:</b> Only the Honeywell/AlarmNet IP cameras will work with Total Connect Remote Services. Refer to <a href="https://mywebtech.honeywell.com">HTTPS://mywebtech.honeywell.com</a> or <a href="http://www.tuxedotouchtoolkit.com">www.tuxedotouchtoolkit.com</a> for the “Camera Compatibility” documentation.
<b>RTSP Streaming URL</b>	Real Time Streaming Protocol, if using a Non-AlarmNet IP camera, this information will be retrieved from the camera or the cameras interface page
<b>Mobile Streaming URL</b>	Fixed
<b>HTTP Port</b>	Default value = 80. To change enter valid port number (80 (1024-65534)). <b>NOTE:</b> Do not use ports 6665-6669 for camera HTTP configuration. These ports block MPEG streaming and PT commands of Safari based PC and mobile devices
<b>Frame Rate</b>	Options are 1, 2, 3, 4, 5, 6, 8, 10, 15, 20, 25, or 30.
<b>User Name/Password</b>	Administrative password to access the camera’s setup or viewing page.

**NOTE: Every camera manufacturer makes their cameras slightly different, so Honeywell does not guarantee that Tuxedo will work with every camera that supports the above network and codec features.**

If using Total Connect, press **Total Connect**  to reset the camera for remote viewing. This programs the camera to default for Total Connect compatibility. A pop-up window displays: **“For remote camera viewing service, please contact your alarm company and ask for Total Connect™ service and provide the camera's MAC ID XX:XX:XX:XX:XX:XX. Press continue to prepare the camera for Total Connect service.”** Press **CONTINUE** or **CANCEL**. Pressing **Continue** provides a confirmation window, which displays: **“Do you want to reset the Camera?”** **Yes** or **No**. See **Remote Access** section, later in this document. Press **Save** when done. Use **Refresh**  to update the screen, if necessary.

## Setting the Camera's Wi-Fi

If the camera is configured as a LAN connection, and the final installation location is only accessible wirelessly, the **Camera WiFi**  option will allow you to assign the camera to the Wi-Fi network. After all cameras have been added, press **Camera WiFi**  to enter the camera wireless settings information from your router. The screen displays: **"INFO: Camera Wi-Fi setup is applicable only for discovered cameras."**

1. Enter the appropriate wireless information:
  - **SSID:** ANY
  - **Security Mode:** Disabled, WPA personal, WPA2 personal, or WEP
  - **Network Type:** Infrastructure
  - **Domain:** USA
  - **Channel:** Auto
1. For **Security Mode**, enter the appropriate information:
  - **Tx Key:** 1, 2, 3 or 4; WEP Encryption: 64 bit Key (10 Hex Chars) or 128 bit Key (26 Hex Chars) , WPA and WPA2.
  - **Authentication:** Open System or Shared Key
  - **Passphrase:** press **GENERATE**
  - **Key:** must consist of 10 hexadecimal characters
2. Press **Apply to All** to set cameras for wireless operation. Press **Save** when done. A pop-up window displays: **"Info XXX.XXX.X.X WIFI Configuration Saved."**
3. Remove the LAN cable and reboot the camera. Once rebooted, verify the can be viewed wirelessly via the Tuxedo. If the camera does not have wireless capability, leave the camera connected to the router via the LAN connection.
4. Press **Camera Settings**  to enter Video, Network, Wireless, and Other settings, if required; refer to **Advanced Camera Settings** below.
 

**NOTE:** Cameras must be enrolled to access the **Settings** screen. If multiple cameras are enrolled, highlight the desired camera to make changes.

## Advanced Camera Settings

All features below can be changed based on the settings required. Press **Camera Settings** to access the following settings.

### NOTES:

- Press **Save!** after each selection
- Fixed Quality is not an option on the Camera Settings home screen.

### Video

Feature	MPEG-4, MJPEG and H.264 Settings
Resolution	160x120, 320x240, 640X480
Fixed Quality	Very Low, Low, Normal, High, Very High
Max Frame Rate	1-8, 10, 15, 20, 25, 30

### Network

Feature	Options
Internet Connection Type	Dynamic or Static IP
IP Address, Subnet Mask, Default Gateway	Network settings (usually settings for setting up for static or a DHCP reservation list)
UPNP	Enables the discovery option in the camera when the Discover  is pressed
HTTP Port	Options are 80, 1024-65534
RTSP Port	Real Time Streaming Protocol Port (default is 554)

### Wireless

Feature	Options
SSID	Network Name
Security System	Disabled, WPA Personal, WPA2 Personal
Passphrase/ SharedKey	Password
N/W Type	Ad-hoc or Infrastructure
Domain	USA
Channel	Auto

Others	Feature	Description and Options
	Reset to Default	Factory defaults the Camera A pop window displays: <b>“Do you want to reset the Camera”</b> select <b>Yes</b> or <b>No</b>
	Restart Camera	Provides a reboot of the camera

 Camera functionality is supplementary only and has not been evaluated for agency compliant installations.

## Removing Cameras











1. To delete a camera, highlight the camera name and press **DELETE**. A confirmation window displays **“Do you want to delete “the selected” camera? Yes or No.** If **Yes** is selected, a message **Select Yes to permanently remove the camera name device from the list.** **Note: select delete all then select discover to rediscover all devices”** appears.
2. To delete all cameras, press **DELETE ALL**. A confirmation window displays **“Do you want to delete all cameras?” Yes or No.**

**NOTE:** If any single camera is removed, all cameras must be removed before that camera can be re-added to the camera list. This is done by performing a **Camera Discovery**.



## Viewing Cameras

Cameras can be viewed locally from the Tuxedo keypad.

**NOTE:** To setup and view cameras for use with Wi-Fi enabled devices and Total Connect, refer to the **Remote Access** section later in this document.

Camera Icons									
									
Camera Settings	Play	Auto Pan	Quad View	Full View	Pan/Tilt	Connect	Reset	Record	Recording Settings

To view cameras locally, do the following:

1. Press **Multi-Media**  > **Camera View/Record**  .
2. Highlight the **View Cameras** button; images from installed cameras appear.
3. Use the **Quad View** button to view up to four cameras on the same screen.
4. Select a quadrant area on the screen and then select the camera that you want to appear in that quadrant.

**NOTES:**

- For pan/tilt style cameras, use **Pan/Tilt** to change the angle of the selected camera.
- Camera Play/Pause functionality is not supported from the web access.
- If the resolution is greater than 320X240, the keypad will crop it to 320X240.

## Video Recording & Event Viewing

The camera **Recording** feature allows you to create a scene that records two minutes of video events onto the SD card. The first 15 seconds records the pre-event and the remaining time records the post-event. Up to four simultaneous video events can be recorded and the first four supported cameras will be associated (automatically) to the recording. An SD card is required to store the recordings.

For proper recording, use the following camera settings for the resolution and frame rate:

- 640X480, less than 5 frames per second
- 320X240, less than 8 frames per second

### Critical Events

This option is enabled in the **Creating Scenes** section. When this option is enabled, a maximum of two events are recorded even when the SD card is not available. If more than two critical events occur, then the older one is replaced by the latest event.

 Video recording is for lifestyle and awareness purpose only. Using this feature for life safety, person and property protection should be prohibited. It is not certified for any agency compliant installations, because it may fail at any time without any notice.

To access the recording feature:

1. Press **Camera View/Record**  > **Camera Setup**  > **Camera Settings** . To change the settings for resolution, fixed quality and frame rate, see the **Camera Add/Edit** section.

**NOTES:**

- The recommended frame rate is eight frames per sec, when setting the resolution to 640 x 480.
  - The recommended frame rate is no more than 15 frames per second, when setting the resolution to 320 x 240.
  - To get a 2-minute recording the **Frames Per Second** should be 5 frames or less
2. Press **Save** when done. This will return you to the *Camera Setup Management* screen.

3. Press **Recording Settings**  and select a camera to assign to “Recording Cam 1-4” from the drop down list.

**NOTE:** This is where the camera is assigned when **Creating a Scene** to activate a camera on an event.

4. Press **Save** when done.

---

## Manual Video Recording

The camera-recording feature can also be used manually to record events to an SD Card (supplied).

To access the manual video recording feature, press **Camera Record**  on the camera view screen.

Select the desired camera for recording and then press **Record**  to begin recording.

Press **Record**  again to stop the recording.

**NOTE:** The maximum recording duration is two minutes.

---

## Using Third Party Cameras

The Tuxedo keypad can support cameras by multiple manufacturers. For a complete list visit <https://mywebtech.honeywell.com/> or [www.tuxedotouchtoolkit.com](http://www.tuxedotouchtoolkit.com) and refer to the IP Camera Compatibility List for supported cameras.





**General Notes:**

- A maximum of four cameras can be enabled for remote viewing with the same account activation. If more than four cameras are needed for remote viewing, user can use manual port forwarding in router. For manual port forwarding, the recommended internal port configuration is 80 for HTTP and 443 for HTTPS.
- Cameras can be enabled or disabled from the Tuxedo Camera Setup screen for remote viewing.
- Using the Multimedia camera view, and other web pages, there are the chances that the session could timeout and the connection with Tuxedo web server will be terminated. In this case, the top bar status updates and all other status updates from Tuxedo will fail. It is advised to refresh the page and continue using the web application.

---

## Event Viewing

To view a cameras’ recorded event:

1. Press **Multimedia**  > **Event View** ; the list of events appears on the screen.
2. Press **Event View Setup**  and select the **Filter by Camera** button to view a specific cameras’ event, select **Show All** to view all camera events or select **Filter By Critical** to view (if enabled) a maximum of two events that have been stored, when the SD card is not available.
3. Press **Save** when done.
4. Highlight the event from the list to view, and press **Play** .
5. Use **Delete**  to remove the event video.

## Video Playback

A Video Converter is required to convert videos for proper playback on the Tuxedo. Use an Internet search engine to locate and download a Video Converter, then follow the steps in the Video Converter Instructions (provided in the carton). Formats supported are MPEG4 and H.264, containers AVI, MOV, MP4.

Press **Product/Training Video**  (located on the Home screen) and view the “SD Card Video Playback” video.

1. Insert your personal media (SD/SDHC) card (with stored video files).

2. Press **Video**.

Use the slide bar to scroll through the video list. Highlight a video file from the list and press **Play**  to start the selected video file.



3. Press **Repeat** , which will continually replay the selected video. Deselect **Repeat** to automatically play the complete list of video files starting with the first video and ending with the last.

4. Press the appropriate icons to **Pause** , or view a **Full View** .

### NOTES:

- Maximum video resolution for video playback is 640 x 480.
- If the video file causes Tuxedo to lock, use a small object (such as a paper clip) to press the reset button located in the lower right-hand side of the keypad to reset. See the **Keypad Reset** section.
- Videos cannot be played when the **EN50131 Display** is turned ON.
- To exit **Full View** mode at any time while a video is playing, press anywhere on the screen.
- When in **Full View** mode there is an 8-10 second delay for video display.
- Removing the SD card during a recording session can cause the unit to lock up and require a reboot.
- Whenever the panel status changes, the camera streaming, video, and play backstop.

## Creating Scenes for Camera Recording

To create a scene for camera recording, from the “Home” screen, press **Automation**  > **Scene Setup**  > **Add**

**Scene** .

In the Trigger section, press **Edit** to define the event **Trigger type**. Press **Save** when done.

In the Action section, press **Add** > **Event Action type** > **Recording**. Select the camera(s) that are desired for recording; press **Save** when done.







Refer to the section **Creating Scenes** section for further detail.

### NOTES:

- In some cases, you may see the video playback for the duration of less than the full two minutes. If this occurs, it is recommended that you lower the frame rate and resolution to 320 x 240 @ 5 FPS.
- Recorded video events are always in 24-hour format regardless of keypad time format.
- Removing the SD card during video recording and playback may cause SD card corruption and loss of data. To ensure recording is not in progress, before removing the SD card, check the video recording status by exiting the Video Event screen and checking **Recording Status** on the lower left side of the Home screen.

## Message (Voice Memo’s)



Leaving a voice memo provides the ability to record a 2-minute custom message. Press **Message**  and enter the appropriate code to access the “Message” options. The following icons are revealed:

Icon	Name	Description
	Record	Starts the recording process, once <b>Record</b> is pressed it will change to  , stopping the recording is accomplished by pressing the button again.
	Previous Message	Moves in reverse and selects the previous Message
	Play	Plays the selected message
	Next Message	Moves forward and selects the next messages
	Delete	Deletes the selected message
	Delete All	Deletes all messages

---

## Recording a Message

---

1. Press **RECORD**  and record your message while staying within approximately one foot of the keypad and speaking at a normal voice volume. As you are recording your message, the remaining time counter counts down to indicate the total remaining time available and a **“Recording New Memo...”** message is displayed above the message list window.
2. Press **STOP**  when you are done recording the message.



**NOTE:** Upon completion of the recording the Message LED will flash.

---

## Listening to a New Message

---

To listen to a voice message:

1. Highlight the message and then press **PLAY** . As the message is being played, a **“Play (#): Voice Memo...”** message is displayed above the message list window. The Message LED continues to flash until all new messages have been played back entirely. When the end of the message is reached, the playback stops.
2. To listen to the next message or previous message, press **NEXT**  and **PREV** .

**NOTE:** The message LED will stop flashing when all messages have been heard.

---

## Deleting Message(s)

---

To delete the selected message, press **DELETE** . A confirmation window is displayed stating:

**Del Selected**  
**Selected Memo 2: 11/02/12 00:30:00**  
 Select **Yes** or **No**.

To delete all messages, press **DELETE ALL** . A confirmation window is displayed stating:

**“Confirmation”**  
**Do you want to delete all messages?**  
 Select **Yes** or **No**.

To exit, press **Back**  > **Home** .

### Notes:

- Each message is numbered, dated and the length of the message in seconds (Sec) is displayed on the message list.
- Use the slide bar to raise and lower the message volume.

## Z-Wave Setup

Before a Z-Wave device will work in the home control network, it must be added (also called included) into the network. View the Programming of Z-Wave Devices training video and follow the instructions below to add and control devices in a home control network.

 **EXISTING NETWORK NOTE:** Z-Wave products from other manufacturers can be included (added) into the Tuxedo network at any time. Z-Wave devices that are always powered can serve as repeaters regardless of manufacturer

 **WARNING:** Automation is intended for lifestyle convenience. Do not use automation for life safety and property protection.

Agency compliant installations application notes:

- 
- Automation functionality is supplementary only and has not been evaluated.
  - Z-Wave applications have not been evaluated.
  - Access control functionality has not been evaluated and may not be used.

The Z-Wave setup is accessed by pressing **Automation**  then **Z-Wave Setup** . Below is a list of the icons that will appear:

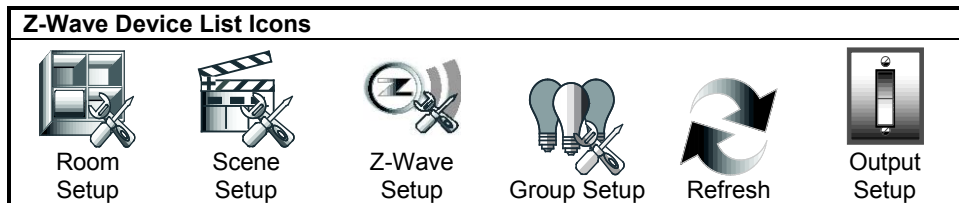

## Z-Wave device Management Screen Device List

The “Z-Wave Device Management Screen Device List” is composed of 5 columns.

**DEVID** Displays the device or “Node” ID displayed in numerical order as you “Include” or “Add” Devices  
**NOTE:** Once a device is excluded, that node number cannot be used again, unless the controller is defaulted.

**NAME** Displays default and custom device names

**TYPE** Displays the Z-Wave device type (i.e. multilevel switch, binary switch, entry controller, etc.)

**INFO** Displays the following Icons:



**Router:**

The device is a routing slave and can be used as a repeater.

**Chain Link:**

The node (device) can send unsolicited messages to the Tuxedo.

**Pad Lock:**

Secured Network Supported

**STATUS** Displays the following messages:

**Success Network** The node has reported a normal status report.

**Failed** Communication with this device has been lost.

**Update Success** Search was successful when running “Search Devices” operation on a device.











**Update Failed** Search was unsuccessful when running “Search Devices” operation on a device.

**Not in Secure Network** Device is expected to be secured (such as an entry controller, but failed to receive the encrypted key. (Remove device and add again closer to the Tuxedo.)

**Up Date Timed Out** This message appears when a device does not respond when requested during a “Scan Network” is performed.



## Z-Wave Device Management Buttons Defined

	<b>Add Device</b>	This icon is for including or adding a new device to the network. <b>NOTE:</b> Refer to the devices installation instructions for the Add and Remove procedure.
	<b>Remove Device</b>	This icon is for removing, or excluding, a device from the devices current network. However, the device does not have to be on the same network. <b>NOTE:</b> Refer to the devices installation instructions for the Add and Remove procedure.
	<b>Abort operation</b>	Pressing the Abort button cancels the “Z-Wave Add Device” or “Remove Device” operation.
	<b>Remove Failed</b>	If a device, or node, is no longer operational, or will not remove by using the “Remove Device” operation, it will remove the device from the list.
	<b>Device Setup</b>	Editing the device is for changing the defaulted name to a custom descriptor chosen by the installer or end user <b>NOTE:</b> This is also the location for changing the icon.
	<b>Search Device</b>	If a device is no longer functional, this option allows you to press the desired device, press <b>Search Device</b> and the Tuxedo will scan the network for the device. If successful, the device route will be updated. If failed, then the device was not found by the Tuxedo.
	<b>Scan Network</b>	The “Scan Network” operation rebuilds the entire Z-Wave network by determining the best route for each device and updating the network routing table. This is designed to improve Z-Wave network’s performance. Also known as Z-Wave <b>“Network Rediscovery.”</b>
	<b>Z-Wave Reset</b>	The ability to reset the Z-Wave controller without resetting the Tuxedo, it power cycles the internal Z-Wave card.
	<b>Z-Wave Default</b>	Press the icon to request a new network ID, or remove all the existing devices. (Note: This does <b>NOTE</b> remove each device. Once defaulted, you must use the remove device operation on each device. If this operation is not completed the device cannot be included into the new network.
	<b>Primary Controller</b>	This icon will display the current role of the controller. If the device displays a “P,” it is the primary controller and can add and remove devices. If the device displays an “S” it is a secondary controller and is only there to display and control devices. Example, if used in conjunction with an additional Tuxedo keypad and experiencing network performance issues, the Tuxedo can be used to extend the network by programming it in as a secondary controller to the Tuxedo’s network. It cannot add and remove devices.
	<b>Secondary Controller</b>	

## Adding and Deleting Z-Wave Devices

Adding and Deleting Z-Wave devices on the Tuxedo keypad depends on the button pressed. For adding a device press

**Add Device** , for removing devices press **Remove Device** . In each situation, refer to the installation instructions on the Z-Wave device for the proper procedure for adding and removing from the Z-Wave network.

### Add a Light, Switch or Outlet Module

1. Install device according to the manufacturer’s directions.
2. Press Add Device .
3. Power the switch on and verify the device module is ON. Press **Function Key** and follow the on-screen messages until Device added successfully is made.

### NOTES:

If a dimmer module was added a slide bar (to control the dimmer) displays.

If an on/off light, appliance, switch or outlet module was added, an On/Off button (to control the device) displays.

### Add a Door Lock

1. Assemble the Z-Wave door lock according to the manufacturer’s directions. **Be sure the door lock orientation/handedness is correct.**
2. Refer to the Door Lock Instructions and connect necessary cables, then install batteries.
3. Enroll the door lock (refer to the Door Lock’s Instructions Guide for procedure.)
4. Press **Add Device** .

**NOTE:** Locks with older firmware require enrollment within 10' of the lock. Newer locks, with updated firmware, do not require this limitation. Refer to the manufacturer of the lock for more information. If the lock will not enroll, try adding a device in between the keypad and the lock. If that does not work, bring the lock closer to the keypad to enroll.

5. Follow the on-screen messages until **“Device added successfully.”**
6. To verify activation on the Tuxedo, click **Back**; wait 30 seconds. Click **Refresh**; the new device is displayed.

**NOTES:**

- Tuxedo has the capability to monitor status of lock and determine whether locked, unlocked, and low battery.
- If the lock is not working, verify the lock is still in a **Secure Network**, if so rescan for devices. If the lock says **Not in Secure Network**, it must be deleted and re-enrolled in the Tuxedo.
- Some manufacturers will not transmit status during a low battery condition.



The Tuxedo will **NOT** push the user codes to the lock. Therefore, any user code in the panel can be used in the lock, but has to be separately programmed in the lock itself. Refer to the locks installation instruction for programming instructions.

---

**Add a Garage Door Controller**

1. Assemble the Z-Wave Garage Door Controller according to the manufacturer’s directions.
2. Refer to the Garage Door Controllers instructions and connect necessary cables and for the Z-Wave Add/Remove procedure.



3. Press **Z-Wave Add Device**.
4. Follow the on-screen messages until **“Device added successfully.”**
5. To verify activation on the Tuxedo, click **Back**; wait 30 seconds. Click Refresh; the new device is displayed.



**Do not use any garage door automation with any garage door opener that lacks the safety features required by U.S. federal safety standards (this includes any garage door opener model manufactured before January 1, 1993). A garage door opener that cannot detect an object, stop, and reverse the door – does not meet current U.S. federal safety standards. Your garage door opener also must signal before unattended door operation. For more information, please consult your garage door opener manual.**

---



**Add a Water Valve**

1. Assemble the Z-Wave Water Valve according to the manufacturer’s directions.
2. Refer to the Water Valve Instructions and connect necessary cables and water pipe fittings. Also, review the procedure for the Z-Wave Add/Remove procedure.



3. Press **Z-Wave Add Device**.
4. Follow the on-screen messages until **Device added successfully.**
5. To verify activation on the Tuxedo, click **Back**; wait 30 seconds. Click Refresh; the new device is displayed.

**Add a Honeywell Thermostat**

1. Install thermostat according to the manufactures instructions. Device should be mounted in the final location and tested before adding it to the system.
2. Press **Z-Wave Add Device**.
3. On the Honeywell thermostat select **Thermostat**; set the “Time/Date” and follow the instructions in the thermostat Installation Guide for “Z-Wave enrollment/inclusion.”
4. Wait a few seconds for the enrollment to finish and the on-screen message “Device added successfully” appears.
5. To complete, press **Done** on the thermostat.
6. Press **Exit** to return to normal operation.
7. To verify activation: on Tuxedo, press **back**  ; wait 30 seconds. Press **Refresh**  ; the new device is displayed.

**NOTES:**

- If not using a Honeywell thermostat, enrollment procedure may vary. Refer to the Thermostat instructions.
- Some thermostats do not update temperature status automatically (i.e., Wayne Dalton).
- If you change the thermostat temperature and immediately go to the thermostat screen, the values are shown as zero because the status has not updated the controller.
- Some thermostats may not provide all the options, which are provided/shown in Tuxedo. If any operation, which is not being supported by the thermostat, is executed from the tuxedo, the thermostat will just ignore the request.

- Radio Thermostat CT100 will not transmit the Celsius scale to the Tuxedo keypad, so it will only work in Fahrenheit mode.
- Intouch Thermostats will not send status during a low battery condition.

 Honeywell is not responsible for property damages due to improper wiring and setting of the thermostat modes.

## Z-Wave Device Setup

### Changing the Name

To change the Z-Wave device icons, do the following:

1. Press **Automation > Z-Wave Setup** to display the “Z-Wave Device Management” screen.
2. Press Z-Wave device to be edited.
3. Press on the text box, which will produce a keypad, allowing you to edit the name. Press, “Go” when finished saving the name.

### Changing the Icon

To change the Z-Wave device icons, do the following:

1. Press the Z-Wave device to be edited.
2. Beneath device name, select the icon to represent the switch.

#### NOTES:

- This applies to Binary (On/Off), Multilevel (Dimming) switches and Water Valves.
- This is a local change only; the icons do not synchronize with Total Connect.
- The FortrezZ® and Leak Gopher® Water valve learn in as a Water Faucet icon by default, but is changeable. All other water valves may learn in as a binary switch.
- All Water Valve commands are excluded from the “All Switches On/Off” command by default.
- Changing binary switch to Water Valve also excludes it from the “All Switches On/Off” command.

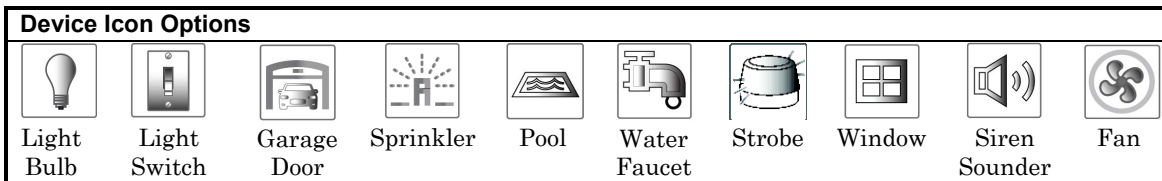

#### Secondary Tuxedo Note

Any device assigned to a water valve icon on the primary Tuxedo must be assigned to the same device on the secondary Tuxedo. Failure to do so results in the water valve responding to the “All Switches On/Off command.”

## Association Details

Each Z-Wave enabled device has a maximum number of secondary controllers, in which it has the ability to send updates. Example, a thermostat may have the ability to send up to five additional Tuxedo's on the same network. However, other manufacturers may not have that ability (as depicted in the table below).

**NOTE:** If the value is zero, the device will only report status to the primary Tuxedo and the user will need to refresh the keypad to get the latest device status. If the value is one, then it will report status to the primary Tuxedo and one other secondary controller (Tuxedo).

Z-Wave Device	Manufacturer	Associations Supported
Thermostat	Trane®	5
	CT100 & CT32®	2
	Honeywell ZWSTAT®	5
	Intouch®	0
	Current innovation®	2
	Wayne Dalton®	0
Locks	Schlage®	2
	Kwikset®	5
	Yale®	5
Garage Door	Linear®	1
Water valve	Fortrezz®	0
	Leak Gopher®	5
Binary Switches	GE®	0
	Homemanagables®	0
	Home Settings®	0
	Wayne Dalton®	0
Multilevel Switches	GE®	0

## Z-Wave Network Update

After all Z-Wave devices have been successfully enrolled, you can perform a Z-wave network update to individual devices or the whole network.

### Individual Device Update

1. Press the device, and then press **Search Devices** .
2. One of three separate messages are display: **“Update failed,” “Update success,”** or **“Update Timed Out.”**
  - If the update fails, move device within closer range of each other or try to add a repeater device in between to extend the range.
  - If the update is successful then it has remapped the route to the device.

### Complete Network Update

This option is helpful when Z-Wave network issues arise. When **Scan**  is pressed the Z-Wave controller searches for the best path (route) to each device (which remaps the Z-Wave network).

1. Press **Scan** .
2. Tuxedo will scan the Z-Wave network and complete the discovery. The onscreen message **“Discovery is about to start please wait...”** displays.
3. When done, the message displays **“Discover Result... 1 device(s) are not found during discovery. See the device list for those devices. Try to add repeater devices to extend the range or move devices closer to each other. Please run the discovery process again.”** Follow the suggestions in the message.

#### NOTES:

- This process may take several seconds/minutes based on the number of devices enrolled.
- If user wants to continue with other operations, they can close the pop up and go navigate to the home screen.
- The Z-Wave install screen will be blocked and enter Z-Wave screen again until the status refresh complete.
- The message **Discovery in progress, remaining time XX:XX. Device Found: X/XX.**
  - Remaining time is determined by the number of devices found.
  - Device found, will list the total number of devices found and scroll through the devices as they are found.



## Creating Scenes

The system can automatically activate devices when certain triggered events occur. When a programmed trigger/condition occurs, the defined device(s) activates. The programming of these triggers and actions is called Scenes. A scene consists of a trigger, an optional condition, and up to five actions. Up to 30 local (20 more using Total Connect Remote Services) scenes can be defined. Scenes must have at least one trigger and one action to initiate. Remote scenes are viewable from the keypad. However, they can only be viewed; editing is done through Total Connect.

The user can access scenes by pressing **Automation**  > **Scene Setup** . The screen will display a table.

Column	Description
<b>SI.No</b>	Represents the scene number.
<b>Name</b>	Names assigned to the scene.
<b>Status</b>	Enabled or Disabled. This allows the option to enable or disable the scene for occasions the scene is not desired.
<b>Manual Run</b>	Gives you the option to run the scene manually to verify its functionality. Also used for testing the scene on initial setup to confirm all actions are taking place.

The other options are:

Name	Description
<b>Local</b>	Lists all of the scenes programmed locally in the keypad
<b>Remote</b>	Lists all of the scenes programmed through Total Connect Remote Services. These scenes cannot be edited, only viewed for their settings. The only option to edit is through Total Connect.
	Press to add a new scene.
	Press to remove an existing scene.
	Press to edit an existing scene.

## Defining Scenes

The system can automatically activate various devices when certain events occur based on predefined Scenes.

<b>Trigger</b>	Defines the event that triggers the programmed action(s). Triggers include the following categories: <table border="1" style="margin-left: 40px; width: 100%;"> <tr> <td>Time</td> <td>Security</td> <td>Thermostat</td> <td>Door</td> </tr> <tr> <td>Garage Door</td> <td>Water Valve</td> <td>Zones</td> <td></td> </tr> </table>	Time	Security	Thermostat	Door	Garage Door	Water Valve	Zones	
Time	Security	Thermostat	Door						
Garage Door	Water Valve	Zones							
<b>Condition</b>	Defines an optional event that puts a condition on the trigger. If a condition is set, the condition must exist at the time of the trigger for the action to occur. Conditions include the same categories as triggers. However, conditions cannot be set with the same category as the trigger. (ex., if setting a trigger event for security, you cannot use security as a condition).								
<b>Action</b>	Defines the desired device action when the trigger event occurs. Actions include the following categories: <table border="1" style="margin-left: 40px; width: 100%;"> <tr> <td>Security</td> <td>Light</td> <td>Thermostat</td> <td>Door</td> </tr> <tr> <td>Garage Door</td> <td>Water Valve</td> <td>Recording</td> <td>E-Mail</td> </tr> </table>	Security	Light	Thermostat	Door	Garage Door	Water Valve	Recording	E-Mail
Security	Light	Thermostat	Door						
Garage Door	Water Valve	Recording	E-Mail						

1. Press **Add Scene** .
2. Press **Scene Name**; enter a name.
3. Assign the desired **Condition**, **Trigger**, and **Action** for this Scene, See **Scene Options** section for detailed information.

**NOTES:**

- After each selection click **Save!**
- Scenes **cannot** be triggered using panic zones 995, 996 and 999 on commercial panels and panic zones 95, 96 and 99 on residential panels.
- A scene consists of a trigger, an optional condition, and up to five actions.

**Example:** You want the lights to turn on when you arrive home and disarm the system, but only at night.

- Trigger: “when the system disarms” > Set the Trigger to **Security: System Disarm.**
- Condition: “only at night” > Set the **TIME condition** (enter the Start Time and Duration)
- Action: “Turn the lights ON” → Set the **Action to LIGHT: ON.**

<b>Trigger</b>	Defines the event that triggers the programmed action.	
	Triggers include the following categories:	
	<b>Time</b>	Choose <b>Time</b> the action should begin: <b>Repeated</b> (choose the days of the week) <b>Once</b> (enter the date) <b>Sunrise/Sunset</b> (region must be set in weather and internet is required) <b>By Clock</b> (set the time the scene should begin) <b>Critical Event</b> (See the <b>Critical Events</b> section)
	<b>Security</b>	Choose <b>Security</b> upon which the action begin: <b>Disarm</b> (action starts when the system is disarmed) <b>Away</b> (action starts when system is armed Away mode) <b>Stay</b> (action starts when system is armed Stay mode) <b>Night</b> (action starts when system is armed Instant or Night mode) <b>Away Secured</b> (action starts after exit delay expires) <b>Alarm</b> (action starts on any alarm condition) <b>Critical Event</b> (See the <b>Critical Events</b> section)
	<b>Thermostat</b>	Choose <b>Thermostat</b> at which the action begin: <b>Above</b> (set the temperature) <b>Below</b> (set the temperature) <b>Critical Event</b> (See the <b>Critical Events</b> section)
	<b>Door</b>	Choose <b>Door</b> at which the action begin: <b>Locked</b> (action starts when the door is locked) <b>Unlocked</b> (action starts when the door is unlocked) <b>Code Unlocked</b> (action starts when door is unlocked by manual code entry) <b>NOTE:</b> Code Unlocked is not a function of Schlage® Locks <b>Critical Event</b> (See the <b>Critical Events</b> section)
	<b>Garage Door</b>	Choose the <b>Garage Door</b> which the action begin: <b>Opened</b> (action starts when door the status of the door changes to open) <b>Closed</b> (action starts when door status of the door changes to close) <b>Critical Event</b> (See the <b>Critical Events</b> section)
<b>Water Valve</b>	Choose <b>Water Valve</b> which the action to begin: <b>Opened</b> (action starts when valve opening is finished) <b>Closed</b> (action starts when valve closing is finished) <b>Critical Event</b> (See the <b>Critical Events</b> section)	
<b>Zones</b>	Choose <b>Zones</b> , which causes the action to begin: <b>Restore</b> (for trigger only; not for use with conditions) <b>Alarm</b> (upon an alarm from a specific zone or zones) <b>Fault</b> (upon a fault from a specific zone or zones) <b>Critical Event</b> (See the <b>Critical Events</b> section)	

**Condition** Defines an optional event that adds a condition to the trigger. If a condition is set, the condition must exist at the time of the trigger, in order for the action to occur. Conditions include the same categories as triggers; however, the conditions cannot be set with the same category as the trigger. (ex., if setting a trigger event for security, you cannot use a security event as a condition.)

**Scene Setup Options**

Defines the desired device action(s) when the trigger event occurs. Actions include the following categories:

	Disarm Night (Arms Instant)	Away Disarm with Code	Stay Enter User Code
<b>Security</b>	<b>NOTE:</b> A valid user code is required for the system to perform any of the actions listed. Enter the code at the prompt. If the user code is later deleted from the security system, you will need to reenter a valid code at this screen.		
<b>Light</b>	Choose the light option to occur upon the trigger event: On/Off (Multi-Level switches will provide a slide bar.) On for Time		
<b>Thermostat</b>	Off Set Mode	Heat Set Point	Cool
	Set energy mode (normal/savings); if savings selected, see your local programming of the thermostat for settings		
<b>Door</b>	Unlocks Locks		
<b>Action</b>	<b>Garage Door</b>	Open Close	
	<b>Water Valve</b>	Open Close	
<b>Recording</b>	Select the camera to start recording after the selected trigger. <b>Warning:</b> Video recording is for lifestyle and awareness purpose only. Using this feature for life safety, person and property protection should be prohibited. Video recording is not applicable for agency compliant applications. Due to a number of “onsite” variables the recording may fail at any time without notice. <b>NOTE:</b> If the SD card is full and a manual scene is executed, a message stating, “SD card is full” will not display and the event will not record.		
<b>E-mail</b>	Select the <b>Email Recipient(s)</b> to receive a custom message, based on the triggered event. <b>Configure E-Mail Id’s:</b> This option allows the assignment of 4 email addresses to the selected action. Enable the SMTP port settings and SSL option must be enabled for the mail feature to operate. SMTP options for Gmail is 465, 587, and 995. For Yahoo they are 465 and 995. <b>NOTE:</b> For commercial applications, the user may need to update their firewall policy.		
		<b>WARNING:</b> Disarm, Garage Door Open, and Door Unlock actions will not be executed on voice command trigger.	



### Voice Input Command

Review the Tuxedo Touch **Voice Command Training Video** before the initial trigger assignment. The Voice Input Command is configured in **Scene Setup**. Voice Commands are accessed by pressing **Voice Input Command**, which provides a drop down window revealing the commands on the table below:

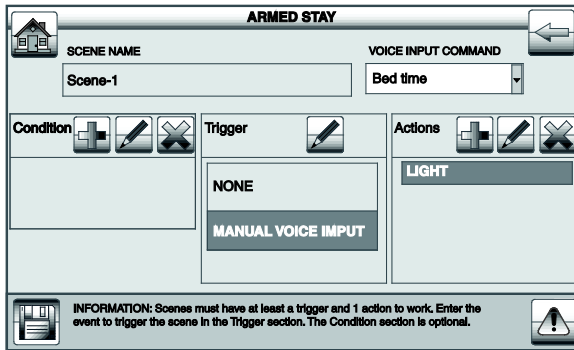

Available Commands
Bed Time
Evening Time
Leaving the House
Returning Home
Wake Up
Cameras

Review the screen shot above. In this setup, the trigger is Bedtime and the action is light (could be light off, on, or dim to a certain level using the slide bar).

1. After assigning a voice trigger to the scene, exit the scene setup page.
2. Speak the voice command **Hello Tuxedo**. The keypad speaks **Please Wait...**, followed by **Hello Tuxedo (XXX)**, Please say your command. The XXX= the command voice accuracy (see the **Voice Tutorial and Setup** section for more information).
3. Speak the selected voice command above.



**Successful Command** will trigger the action configured in the scene. The keypad will speak **“Processing XXXX command”** (XXXX = the command).



**Unsuccessful Command** will not trigger the action configured in the scene. The keypad will not give a confirmation. If the keypad heard the command and could not understand the request it displays **“Please retry by saying the Hello Tuxedo trigger phrase followed by one of the commands: Bed Time, Evening Time, Leaving the House, Returning Home, Wake Up, and Camera.”** See the **Voice Tutorial and Setup** section for troubleshooting steps.

**UL**

Voice Input Commands are supplementary only and not evaluated for UL applications.



The **Camera** Command is an individual trigger, which launches the camera home page; it cannot be assigned to scene.

## Detailed Scene Configuration

---

Scenes must have at least one trigger, 1 action (up to 5) and the event to trigger. The Condition section is optional.



<b>Time</b>	<p>Set the <b>TIME</b>: Press <b>Trigger/Condition &gt; Add &gt; TIME &gt;</b> Set the occurrence.</p> <p>If <b>ONCE</b>, <b>Enter Date</b>; if <b>REPEATED &gt;</b> choose days of the week; if <b>BY CLOCK &gt;</b> press on the <b>Hour/Minutes</b> displayed and enter the <b>Start</b> and <b>End Time &gt;</b> press on <b>AM/PM</b>; if <b>SUNRISE</b> or <b>SUNSET &gt; BY CLOCK</b> until the desired setting is displayed.</p> <p>Check the <b>Critical Event</b> check box to record and store a maximum of two events even when the SD card is not available. If more than two critical events occur, then the older one is replaced by the latest event.</p> <p><b>NOTES:</b></p> <ul style="list-style-type: none"><li>• The <b>Sunrise/Sunset</b> feature is dependent on the “Region” selected in the “Weather Forecast” section and requires internet access for accuracy.</li><li>• <b>BY CLOCK</b> allows you to activate the scene for a specified period.</li></ul>
<b>Security</b>	<p>Set the <b>Security Mode</b>: Press <b>Trigger/Condition/Action &gt; Add &gt; SECURITY &gt; DISARM, AWAY, STAY, NIGHT, AWAY SECURED</b> or <b>ALARM &gt; User Code</b>, if required.</p> <p><b>NOTES:</b></p> <ul style="list-style-type: none"><li>• <b>AWAY</b> triggers upon arming away.</li><li>• <b>AWAY SECURED</b> triggers when exit delay has expired.</li></ul>
<b>Thermostat</b>	<p>Set the <b>Thermostat</b>: Press <b>Trigger/Condition/Action &gt; Add</b>. Press <b>THERMOSTAT</b> and select a <b>Thermostat</b> device from the drop-down menu or press <b>Select Thermostat Group</b> to activate more than one device. See the <b>Group Setup</b> section. Use <b>ABOVE</b> or <b>BELOW</b> to increase/decrease the temperature or press the <b>Temperature Value</b> box and enter two digits for the desired temperature.</p> <p><b>NOTES:</b></p> <ul style="list-style-type: none"><li>• Test thermostats first to ensure proper function in the scene.</li><li>• Some thermostats do not update temperature status automatically (i.e., Wayne Dalton).</li></ul>
<b>Light</b>	<p>Set <b>Lights (on/off)</b>: Press <b>Action box &gt; Add &gt; LIGHT &gt; Select Light Device</b> from the drop-down menu or press <b>Select Lights Group</b> (to activate more than one device) &gt; set the action to <b>ON, OFF</b>, Dim level for multi-level switches; or select <b>ON FOR TIME</b> and press <b>Hour/Minutes &gt;</b> amount time.</p> <p><b>NOTE: ON FOR TIME</b> allows you to activate the scene for a specified period.</p>
<b>Door</b>	<p>Set the <b>Door Locks</b>: In the <b>Trigger</b> box, press <b>Add &gt; DOOR &gt; Door Device</b> from the drop-down menu. Press <b>LOCKED, UNLOCKED</b> or <b>CODE UNLOCKED</b> for the Action. In the <b>Condition</b> box, press <b>LOCKED</b> or <b>UNLOCKED</b>. Next, an action must be programmed.</p> <p><b>NOTES:</b></p> <ul style="list-style-type: none"><li>• Motorized door lock bolts physically lock and unlock when activated, but if the door lock installed is a non-motorized type, activation allows the door to be manually unlocked without a key. See <b>Compatible Devices</b> section later in this document.</li><li>• When using some older Kwikset® Smartcode electronic deadbolt door locks (in a Scene that is programmed to trigger when unlocked) the Scene does not trigger if using a key; enter a user code.</li></ul>
<b>Garage Door</b>	<p>Set the <b>Garage Door</b>: Press <b>Trigger/Condition/Action &gt; Add .&gt; GARAGE DOOR &gt; Garage Door Device</b>, select from the drop-down menu or press <b>Garage Door Group</b> to activate more than one device. Select <b>OPENED</b> or <b>CLOSED</b>. The Action Menu option is <b>OPEN</b> or <b>CLOSE</b>. In <b>CONDITIONS OPENED</b> or <b>CLOSED</b>.</p> <p><b>NOTE: Review the disclaimer</b> in the section <b>Add Garage Door Module</b>.</p>
<b>Water Valve</b>	<p>Set the <b>Water Valve</b>: Press <b>Trigger/Condition/Action &gt; ADD &gt; WATER VALVE &gt; WATER VALVE DEVICES</b> from the drop-down menu or select <b>Water Valve Group</b> to activate more than one device. The options for <b>Trigger/Condition</b> are <b>OPENED</b> or <b>CLOSED</b> and for Action is <b>OPEN</b> or <b>CLOSE</b>.</p>
<b>Zones</b>	<p>Set the <b>Zones</b>: In the <b>TRIGGER/Condition</b> box, press <b>Add</b>. Press <b>ZONES</b> and select a zone from the drop-down menu. Select <b>Restore, Alarm</b> or <b>Fault</b>.</p> <p><b>NOTE:</b> Do not use 24-hour silent zone restore/fault in the pre-condition and trigger fields on commercial panels.</p>

---

## Group Setup

A group is a defined collection of the same type of Z-Wave devices (such as only light modules, or only door locks, etc.) that can be used in scenes. When used in a scene and the scene activates, all devices assigned to that group activate.

Up to 20 groups can be created with up to five of the same type devices in each group, such as five door locks, etc. Follow the procedure below to create a Group.

1. Press **Group Setup**  > **Add** .
2. Highlight **Group Name** > **Group Name**.
3. Select the **Group Type** (Binary Light, Door Lock, Thermostat, Multilevel Switch, Shades, Water Valve, Garage Door Controllers, and Other) from the drop-down list.
4. Highlight the device(s) from the drop-down list that you want to add to this **Group** and press **Save**. A confirmation message is displayed: **Z-Wave device group settings saved**.

### NOTES:

- Select **Edit** to make changes to existing Groups; use **Delete** to delete a Group.
- The “Water Valve Group” is excluded from the “All Switches On/Off” command on the “Device Control” page.

## Room Setup

A room is a defined collection of different types of Z-Wave devices (such as light modules, door locks, thermostats, etc.) which can be used to organize the Z-Wave devices. Up to 50 rooms can be created with no limitation to the number of devices in each room.

**Example 1: Screen Interface**



**Example 2: Assigning Devices**

Room Name	Kitchen	Bedroom	Living Room
Device 1	Kitchen Over Head Light	Bed. Lamp	L.R. Lamp
Device 2	Kitchen Cabinet Lights	Bed. Fan	L.R. Fan
Device 3	Kitchen Fan	Bed Overhead Light	L.R. Outlet
Device 4	Kitchen		

Follow the procedure below to create a Room.



1. Press **Room Setup** > **Add**.
2. Enter a room name > **GO**.
3. Check the box next to the device(s) that will be assigned to this **Room** > **Save**.
4. Select **Edit** to make changes to existing Rooms; use **Delete** to delete a Room.
5. If settings were changed, a pop-up confirmation window displays **Settings Saved**.

## Secondary Tuxedo Controller

After all Z-Wave devices have been added into the Primary Tuxedo (#1), the device information can be downloaded to a Secondary Tuxedo (#2). Up to 231 secondary plus 1 primary controller, for a total of 232. Keep Tuxedos within 40 feet of each other (if it does not work, move the keypad closer to the primary), apply power to Tuxedo #2 and do the following:

1. At Tuxedo #1 (Primary Controller): Press **Automation** > **Z-Wave Setup** ; the “Z-Wave Device Management” screen is displayed.

**NOTE:** If used for Remote Services, Tuxedo should not be configured as a secondary controller. See the **Remote Services** section later in this document.

2. At Tuxedo #2 (Secondary Controller): Press the **Z-Wave Primary**  icon (located in the lower right side of the screen). The icon  changes to an  icon, representing the controller is now in secondary mode.

## TUXEDO TOUCH WI-FI INSTALLATION & SETUP GUIDE

---

**NOTE:** The message **“Please remove all Z-wave devices from network first”** appears if Z-Wave devices are enrolled. If no Z-Wave devices exist, a confirmation will display **“Change to Secondary Controller? Note: Total Connect feature will be unavailable in secondary controller mode.”** Select **Yes** to change this keypad to a Secondary Controller.

3. At Tuxedo #1, Press **Add Device** .
4. At Tuxedo #2: Press **Add Device**, the keypad displays **“Secondary Controller Inclusion Devices Upload in process.”** When device information from the Primary Tuxedo is downloaded to the Secondary Tuxedo:
  - The Secondary Tuxedo displays **“Device Upload in Process.”** Once devices have been uploaded, **“Devices Uploaded Successfully”** is displayed.
  - The Primary Tuxedo displays **“Device Added Successfully.”**

### Notes:



- If the device status is failed, remove and enroll Tuxedo as the secondary controller again and then reboot the system; verify that the two controllers are less than 40 feet apart.
- Device names will NOT be synchronized upon initial Tuxedo Z-Wave device transfer.
- Secondary keypad will not receive device low battery status automatically, must perform a manual refresh.

## Synchronizing Device Names

---

Synchronizing the names of the Z-Wave devices requires a connection the same network (Wi-Fi or LAN).

**Note:** User always has to perform the sync from the secondary Tuxedo.

1. At Tuxedo #2 (Secondary Controller): Press the **Automation**  > **Z-Wave Setup** .
2. Press **Sync Device Names** a message displays **“This will synchronize device name(s) with the primary controller. This will overwrite the device names. Do you want to continue Z-Wave device name(s) sync operation with the primary Tuxedo?”** **Yes** or **No**.
3. A message will be displayed at the top of the screen stating **“Z-Wave name synchronization in process. Please wait...”**
4. When completed the message **“Z-Wave name synchronization completed”** appears and the names are synchronized with the primary Tuxedo.

## Updating Tuxedo with New or Removed devices

When devices are added or removed from the Z-Wave network, the device information needs to be updated in the Tuxedo. perform this update, you must remove the secondary controller and re-enroll.

1. Press **Remove Device** on the Primary Tuxedo > **Remove Device** on the Secondary Tuxedo. Both Tuxedos display, **“Device Removed”** and the Secondary reverts to the Primary Tuxedo.
2. Convert the second Tuxedo back to a primary following the steps above.
3. Press **Add Device** on Primary Tuxedo controller > **Add Device** on Secondary Tuxedo controller. The controller scans for devices in the primary controller and the message is displayed **“Devices added Successfully”** followed by **“Devices Uploaded Successfully.”**

**NOTE:** The secondary Tuxedo must be within 10' of the primary controller for best results.

## Removing Secondary Tuxedo's

---

To remove the Secondary Tuxedo (Controller) press **Remove Device** on the Primary Tuxedo > **Remove Device** on the Secondary Tuxedo. Both Tuxedos display, **“Device Removed”** and the Secondary reverts to the Primary Tuxedo.

## Manual Z-Wave Device Control

---

To access the list of Z-Wave devices and view the status of the enrolled devices, press **Automation**. Use the **OFF/ON/Slide Bar** buttons to control the Z-Wave modules. The Z-Wave devices are group in the following order: **Thermostats, Door Locks, Garage Doors, Multi-Level Switches, Binary Switches, Water Valves and Shades.**

## Integrating Total Connect Remote Services

The Tuxedo supports Remote Services for controlling Z-Wave devices and scenes remotely from an associated Total Connect account.



LAN or Wi-Fi **MUST** be enabled for proper integration with Total Connect. Synchronizing is required before the enabled devices will display in Total Connect.

### Enabling Devices for Total Connect

After devices have been added to the Tuxedo, the next step is to add them to Total Connect.

1. From the home screen press **Setup > System, > CS Setup**. Enter the Authorized code and press **TC SERVER INFO**.
2. Press **TC Enable** , the **Z-Wave Device Management for Total Connect** screen is displayed.
3. Select the device(s) that you want to enable/disable in Total Connect.  
**NOTE: Some devices may need to be enabled after a software upgrade.**
4. Press **Save** when done.
5. After devices have been enabled for Total Connect, follow the Total Connect prompts to synchronize the data with Tuxedo.

#### NOTES:

1. On Total Connect, the maximum number of supported devices is 40 switches (including Water Valves), 3 thermostats, 4 door locks and 3 Garage Door Controllers.
2. Tuxedo supports 232 devices (including the Tuxedo keypads) in the Z-Wave network.

### Controlling Automation (Z-Wave) Devices Remotely

Use Total Connect to control Z-Wave devices: lamp modules (binary switch), dimmer modules (multilevel switch), thermostats, door locks, garage door controllers, water valves, shades, etc., from a smart phone, iPad®, Android™ Tablet, or PC. If accessing on a smart device (Apple or Android) verify the correct App has been download and installed.

1. Access the Total Connect account and navigate to the Automation section of the dashboard.
2. Select a displayed device and click the desired action. Refer to the **Total Connect Online Help Guide** for further details on controlling Z-Wave devices.

## Viewing and Controlling Total Connect Scenes from Tuxedo

Use **Scenes** to display and control scenes that have been created in Total Connect.

1. From the “Home” screen, press **Automation**  > **Scene Setup**  > **Remote**. The screen displays a list of scenes created in Total Connect.
2. To control a Remote scene, select the desired scene, and then click the appropriate action (ex. Run).

### Creating Scenes in Total Connect

The following table summarizes the relationships between Total Connect scenes and Tuxedo scenes:

Controlling Device	Scenes created in Total Connect		Scenes created in Tuxedo	
	View	Edit Scenes	View	Edit Scenes
Total Connect	Yes	Yes	No	No
Tuxedo	Yes	No	Yes	Yes

**Note:** For troubleshooting purposes, Total Connect server information (including IP addresses) can be viewed on the **Total Connect Server Setup** screen by pressing the **TC SERVER INFO** button.

Use the Automation section of the dashboard in Total Connect to create up to 20 scenes. Refer to the **Total Connect Online Help Guide** for further details and device limitations for creating an automation scene.

1. Access the Total Connect account and navigate to the Automation module. Press **Create New** > Enter a name for the scene > select an icon > and then press on the check boxes for the various device actions desired for that scene. Set the thermostat, if used, to the desired mode and/or temperature for that scene. Press **Save** when done.





Scene triggers and actions created in Total Connect can be edited only from Total Connect. Scene conditions cannot be programmed through Total Connect.





2. After scenes have been created, follow the Total Connect prompts to synchronize the data with the Tuxedo. Synchronizing is required before scenes created in Total Connect will display in Tuxedo.

### Total Connect Server Screen for Troubleshooting

The “TC Server Info” screen displays the current server information and Z-Wave device status. This information is typically used for IP connection troubleshooting purposes in collaboration with a service technician.

	<b>Diagnostic Connect</b>	Clicking <b>Diagnostic Connect</b> in the bottom left corner will test the communication status to the AlarmNet server. If the test fails, check your network connection.
	<b>Cancel</b>	This cancels the Diagnostic Test above.
	<b>Total Connect Device Select</b>	Verification of the Z-Wave status: If enabled it will communicate Z-Wave status to Total Connect 2.0. Pressing the “TC” icon will populate a list of all your Z-Wave devices with an enable or disable option. This will allow or prevent those chosen devices from appearing on the Total Connect account.

To access Total Connect Server Information and Z-Wave Status from the Tuxedo keypad, do the following:

1. From the “Home” Screen, press **Setup**  > **System**  > **CS Setup**  > enter the installer code (if required).
2. Press the **TC SERVER INFO** button. The “Total Connect Server Setup” screen is displayed with the current Server information and Z-Wave Status (enabled/disabled).  
**NOTE:** These fields are for reference only and cannot be edited.
3. Press **Connect**  to test the connection to the AlarmNet servers.

## Appendix A: Important Notes

For additional troubleshooting procedures, refer to the Control Panel Installation Guide.

### General Notes

- You may check to see whether the Chime Mode is ON or OFF by viewing the keypad Operating Modes screen as described in the “Operating Modes” section.
- Note that some displays on the keypad may not have enough space to display the full name of a partition. When this occurs, the display shows as many characters as possible starting at the beginning of the partition name. We recommend that the partition name be kept to a maximum of seven characters to ensure the “H” which indicates the home partition may be seen.
- “Exit Error” and “Auto Arm Alert, Please Leave Now” messages are not displayed by the keypad.
- When the system has 6150Vs or 6160Vs, and 6271Vs attached, the Additional Console setting in the 6150Vs (displayed as A on the 6150V) must be set to one and the Additional Console setting in the 6160Vs must be set to Yes.

### Commercial System Notes

- If the Aux Relay function is set for alarm silenced by User Code + # + 67, this command may only be entered in the console emulation mode.
- Do not use the common lobby logic function.
- If fields 2\*22 (Display Fire Alarms of other Partitions), 2\*23 (Display Burg & Panic of other Partitions), or 2\*24 (Display Troubles of other Partitions) are enabled, the zones that created the conditions cannot be viewed. You must go to that zone's home partition to view.
- If field 1\*11 (Zone Bypass After Disarm) is enabled, you must use the keypad's Console Emulation Mode and the commands “Code” + “64” (unbypass all) or “Code” + “6” + “Zone Number” (unbypass zone) to remove zone bypasses.
- The First to Alarm Display Lock feature (field 1\*10) is not supported by the keypad.
- RF Low Battery messages are not supported by the keypad except in the Show Zones screen where a Battery Icon is displayed for the zone with the low battery.

### Residential System Notes

- If the Clean Me option is set, when the maintenance signal is received a “Fire Maintenance” message and the Display Faults is shown. However, if you display the faults, zone 1 is not shown as a faulted zone.
- If RF Jam Reports are selected and RF Jam is detected, the User Authorization screen displays “Trouble ZN100 RF Receiver.” If you enter the console emulation mode, the display shows “Check 90 RF Receiver Jam.”
- Do not use the Custom Word reminder feature.

### User Related Notes

- Users added to the system using the keypad graphic user screen must be deleted from the keypad using the graphic screen as well. Deleting users from the panel by any other means (alpha keypad, console emulation mode, or Compass downloader) does not automatically delete them from the keypad.
- If the panel has exit tones enabled and you arm the system in the Away mode, the keypad beeps continuously throughout the exit period.

Use the console emulation mode for the following functions:

- Programming more than 10 system users.
- Programming the Pager report option for users of residential control panels (e.g., VISTA-15P/20P).
- Special Function Key operations (such as macros or single-button paging).
- End-User Scheduling.
- To check for an “Alarm Cancelled” message (on commercial panels only) if this feature has been enabled in the system.

---

## Appendix B: Z-Wave Notes

---

### Z-Wave Compatible Devices

---

Z-Wave devices may vary; follow the instructions in the *User's Guide* for your specific device when adding and deleting devices into the Z-Wave network.

---



Visit <https://mywebtech.honeywell.com/> or <http://www.tuxedotouchtoolkit.com/> for a complete list of compatible Z-Wave devices. Refer to the document titled “**Z-Wave Compatibility Chart.**”

---

**NOTE:** The listed companies in the document referenced online may manufacturer multiple Z-Wave devices. Installing 'like' modules not included on this list may produce unpredictable results. These devices have not been confirmed as compatible.



## Appendix C: Wireless Range

This device complies with the Z-Wave® standard of open-air, line of sight transmission distances of 100 feet. Actual performance in a home depends on the number of walls between the controller and the destination device, the type of construction and the number of Z-Wave enabled devices installed in the control network.

**Please Note:** Z-Wave home control networks are designed to work properly alongside wireless security sensors, Wi-Fi, Bluetooth and other wireless devices. Some 900 MHz wireless devices such as baby cams, wireless video devices and older cordless phones may cause interference and limit Z-Wave functionality.

### Things to consider regarding RF range:

- Each wall or obstacle (such as refrigerator, big screen TV, etc.) between the remote and the destination device will reduce the maximum range of 100 feet by approximately 25-30%.
- Brick, tile or concrete walls block more of the RF signal than walls made of wooden studs and drywall.
- Wall mounted Z-Wave devices installed in metal junction boxes will suffer a significant loss of range (approximately 20%) since the metal box blocks a large part of the RF signal.



**WARNING: NOT FOR USE WITH MEDICAL OR LIFE SUPPORT EQUIPMENT!** Z-Wave enabled devices should never be used to supply power to, or control the On/Off status or medical and /or life support equipment.

### Controlling Devices:

The features and functions that can be controlled vary by manufacturer and you will need to review the user manual that was provided to determine capabilities of each device.

**IMPORTANT:** Honeywell is not responsible for property damages due to improper setting of the thermostat modes.

### Effects of Home Construction on Wireless Range between Z-Wave Enabled Devices

**Note:** The distances shown in the table below are typical examples. Actual performance in your home will vary. From the Remote (or repeating Z-Wave module) to the destination device:

Number of Walls or Obstacles	Type of Construction			
	Wood Frame with Drywall		Brick, Tile or Concrete	
	Plastic J-Boxes*	Metal J-Boxes	Plastic J-Boxes*	Metal J-Boxes
0**	100 ft.	80 ft.	100 ft.	80 ft.
1	70 ft.	56 ft.	60 ft.	48 ft.
2	49 ft.	39 ft.	36 ft.	29 ft.
3	34 ft.	27 ft.	21 ft.	17 ft.

\* For plug-in modules or in-wall devices installed in plastic junction boxes.















\*\*Line of sight / no obstructions.



CO annunciation has not been investigated for agency compliant applications and may not be used for those installations.

## Navigation Icons

To aid in the navigation through the Tuxedo touch-screens, a set of user-friendly icons has been provided. The appearance and function are described below.

ICON	ICON TITLE	FUNCTION
	"Product/Training Videos"	Accesses the "Product Introduction and Training Videos."
	"Message"	Record and retrieve Voice Messages.
	"Automation"	Accesses the Z-Wave setup, Scene setup, and Group/Room setup screens.
	"Security"	Accesses the "Security" screen.
	"Home"	Returns you to the "Home" screen.
	"Back"	Reverts to the last screen viewed.
	"Panic"	Displays Emergency functions (as programmed by the installer). See programming the Control Panel note. <b>Note:</b> This icon is displayed and active on all screens except while in the Clean Screen mode, during an LCD Display test in <i>Diagnostics</i> , and from the Video and Camera screen.
	"Control Panel Message"	This icon alerts the user to a Control Panel Message.
	"Setup"	Accesses the Setup menus.
	"Multi-Media"	Accesses the Message, Camera, Picture and Video features.
	"Video"	Allows user to play video files.
	"Picture"	Allows user to display personal photos in a slide show format.
	"Voice Status"	Allows user to hear system status.
	"Camera"	Press to access camera settings.
	"Event View"	Press to access video recordings.

## Specifications

**Mechanical Specifications:**

Width: 8.23 inches (209.04mm)  
 Height: 5.59 inches (141.99mm)  
 Depth: 1.13 inches (28.70mm)

**Operating Environment:**

Humidity : 93% RH, non- condensing

**Temperature:**

Operating : 14°F to 131°F / -10°C to 55°C (UL tested 32°-120°F / 0 to 49°C)  
 Shipping / Storage: -40°F to 158°F / -40°C to 70°C

**Electrical Specifications:**

Backlight OFF, Sound OFF, WIFI ON  
 Backlight ON, Sound OFF, WIFI ON  
 Backlight ON, Sound ON, WIFI ON

	<b>9.6VDC</b>	<b>12VDC</b>	<b>13.8VDC</b>
	170mA	140mA	130mA
	280mA	225mA	200mA
	340mA	260mA	250mA

# NOTES

# **NOTES**



## FEDERAL COMMUNICATIONS COMMISSION (FCC) & INDUSTRY CANADA (IC) STATEMENTS

The user shall not make any changes or modifications to the equipment unless authorized by the Installation Instructions or User's Manual. Unauthorized changes or modifications could void the user's authority to operate the equipment.

### CLASS B DIGITAL DEVICE STATEMENT

This equipment has been tested to FCC requirements and has been found acceptable for use. The FCC requires the following statement for your information:

This equipment generates and uses radio frequency energy and if not installed and used properly, that is, in strict accordance with the manufacturer's instructions, may cause interference to radio and television reception. It has been type tested and found to comply with the limits for a Class B computing device in accordance with the specifications in Part 15 of FCC Rules, which are designed to provide reasonable protection against such interference in a residential installation. However, there is no guarantee that interference will not occur in a particular installation. If this equipment does cause interference to radio or television reception, which can be determined by turning the equipment off and on, the user is encouraged to try to correct the interference by one or more of the following measures:

- If using an indoor antenna, have a quality outdoor antenna installed.
- Reorient the receiving antenna until interference is reduced or eliminated.
- Move the radio or television receiver away from the receiver/control.
- Move the antenna leads away from any wire runs to the receiver/control.
- Plug the receiver/control into a different outlet so that it and the radio or television receiver are on different branch circuits.
- Consult the dealer or an experienced radio/TV technician for help.

### INDUSTRY CANADA CLASS B STATEMENT

This Class B digital apparatus complies with Canadian ICES-003.

Cet appareil numérique de la classe B est conforme à la norme NMB-003 du Canada.

### FCC / IC STATEMENT

This device complies with Part 15 of the FCC Rules, and RSS-210 of Industry Canada. Operation is subject to the following two conditions: (1) This device may not cause harmful interference, and (2) This device must accept any interference received, including interference that may cause undesired operation.

Cet appareil est conforme à la partie 15 des règles de la FCC & de RSS-210 des Industries Canada. Son fonctionnement est soumis aux conditions suivantes: (1) Cet appareil ne doit pas causer d'interférences nuisibles. (2) Cet appareil doit accepter toute interférence reçue y compris les interférences causant une réception indésirable.

USE OF THESE PRODUCTS IN COMBINATION WITH NON-HONEYWELL PRODUCTS IN A WIRELESS MESH NETWORK, OR TO ACCESS, MONITOR OR CONTROL DEVICES IN A WIRELESS MESH NETWORK VIA THE INTERNET OR ANOTHER EXTERNAL WIDE AREA NETWORK, MAY REQUIRE A SEPARATE LICENSE FROM SIPCO, LLC. FOR MORE INFORMATION, CONTACT SIPCO, LLC OR IPCO, LLC AT 8215 ROSWELL RD., BUILDING 900, SUITE 950, ATLANTA, GA 303350, OR AT [WWW.SIPCOLLC.COM](http://WWW.SIPCOLLC.COM) OR [WWW.INTUSIQ.COM](http://WWW.INTUSIQ.COM).



### RF EXPOSURE WARNING

The Tuxedo must be installed to provide a separation distance of at least 7.8 in. (20 cm) from all persons and must not be co-located or operating in conjunction with any other antenna or transmitter except in accordance with FCC multi-transmitter product procedures.

**SUPPORT & WARRANTY**

For the latest documentation and online support information, please go to:  
<https://mywebtech.honeywell.com/>

For the latest warranty information, please go to:  
[www.honeywell.com/security/hsc/resources/wa](http://www.honeywell.com/security/hsc/resources/wa).

For patent information, see [www.honeywell.com/patents](http://www.honeywell.com/patents)



MyWebTech



Warranty



Patents



800-16571V2 8/15 Rev. B

**Honeywell**

2 Corporate Center Drive, Suite 100  
P.O. Box 9040, Melville, NY 11747  
Copyright © 2014 Honeywell International  
[www.honeywell.com/security](http://www.honeywell.com/security)